



The New 400 watt turbine!

Owner's Manual

Wind Turbine Serial Number _____

NOTICES:

- This information is believed to be reliable; however, Southwest Windpower, Inc. assumes no responsibility for inaccuracies or omissions. **The user of this information and product assumes full responsibility and risk.**
- All specifications are subject to change without notice.
- Wind generators, like other sources of electrical power, must be installed following the guidelines established by state and local regulations. Consult a local electrical contractor or the local planning and zoning office for details and regulations.
- For your convenience and protection write the serial number of your wind turbine on the front of this manual. Store your purchase invoice with this manual as well. You will need this information in the event of a warranty claim. It also helps the customer service department at Southwest Windpower when you have questions about your specific turbine. Thank you.

Made in the USA by:

Southwest Windpower, Inc.
2131 N. First Street
Flagstaff, Arizona 86004

Toll Free Phone: (866) 805-9463
Phone: (928) 779-9463
Fax: (928) 779-1485
E-mail: info@windenergy.com
Web: www.windenergy.com

***AIR, AIR 403, AIR-X and AIR Wind Module are trademarks of Southwest Windpower
© 2002 Southwest Windpower, Inc.***



CONGRATULATIONS!

You have just purchased the most advanced battery charging wind turbine in the world! We believe you will find it easy to install your **AIR-X**; however, it is important that you read this entire manual **thoroughly** prior to installation to assure proper performance and safety.

Southwest Windpower has over 12 years of experience in designing and manufacturing small wind generators. In just five years, over 45,000 **AIRs** have been sold throughout the world.

What makes the **AIR-X** unique in comparison to other turbines is the use of state-of-the-art technology like Iron Boron Neodymium magnets, carbon reinforced engineering thermoplastics, high-quality aluminum castings, stainless steel hardware and integrated, microprocessor based control electronics. The turbine comes standard with a built-in voltage regulator, quiet computer controlled stall of the blades in high winds, and the best global warranty program in the industry.

The **AIR-X** is for use in applications where salt corrosion is not expected to be a concern. The **AIR-X Marine** is designed for offshore and or land-based coastal applications.

If you have any questions after thoroughly reading the manual, please contact your authorized distributor/dealer or Southwest Windpower, Inc.

Enjoy.

New Features of the AIR-X

The **AIR-X** is the latest evolution of the AIR series of wind turbines from Southwest Windpower. From the outside, the **AIR-X** looks almost identical to the AIR 303 and AIR 403. The improvements are almost all inside the turbine.

The AIR-X Features:

- **New Electronics:** The **AIR-X** incorporates an entirely new rectifier and controller. The microprocessor based controller provides voltage regulation, peak power tracking, and quiet, stall control in high winds. The **AIR-X** uses a synchronous rectifier bridge which results in cooler, more efficient operation. The **AIR-X** also incorporates a voltage boosting function which allows the turbine to reach charging voltage at a much lower RPM.
- **New Alternator:** A more efficient alternator has been built into the **AIR-X**. The alternator was designed to complement the peak power tracking ability of the control electronics. The alternator uses a larger wire size than that of the **AIR 403**, and thus has lower internal resistance. The result is cooler operating temperatures for improved reliability. The strong permanent magnet rotor can be felt in rotating the rotor shaft; a slight “catch” can be felt when spinning the shaft with your fingers. This is normal, and is quickly overcome when the blades begin spinning.
- **New Blades:** The rotor blades use a highly efficient, true airfoil. They are manufactured using a precision injection molding process that produces blades of exceptional consistency. The result is quieter performance and minimal vibration. The **AIR-X** blades differ from the **AIR 403** blades in their tip angles. The **AIR-X** blades have an increased tip angle which improves their ability to start rotating, and moves “flutter” to higher wind speeds. Unlike the **AIR 403** and earlier **303**, the **AIR-X** does not rely on blade flutter for over-speed protection. The control electronics will slow the blades before the turbine reaches the point of flutter. Increasing the tip angle helps to ensure that the flutter noise is not heard.
- **New Yaw Shaft:** The yaw shaft is the part of the turbine that mounts to the tower and allows the turbine to rotate into the wind. The **AIR-X** features a new yaw shaft that allows for stronger clamping forces to the tower, and more rigidity in the turbine.

The AIR-X also retains these features of the AIR 403:

- **Hysteresis Braking:** The regulation control circuitry incorporates hysteresis. This will lock the turbine in a silent regulation mode once the batteries are fully charged. The turbine begins producing power again when the battery voltage drops slightly below fully charged. This means, for a factory set 12V turbine, the turbine will regulate (shut down) when the batteries have reached 14.1V, and will resume charging when the voltage drops to 12.75V. Minimal output is wasted, as non-charging battery voltages above 12.75V represent mostly a “surface charge” with very little energy. This feature prevents the turbine from fluctuating in and out of regulation mode, resulting in a quieter, better-behaved machine.
- **New Body, New Hub:** The **AIR-X** body is made from a precision casting process that not only enhances fit and finish, but also leads to a stiffer, more durable body. The aluminum casting also acts as a heat sink and transfers heat from the stator and the electronics into the wind flowing past the turbine. The die cast aluminum hub design has been engineered to be the strongest, stiffest hub we have ever produced.

Table of Contents

1. Safety Precautions.....	6
1.1 Mechanical Hazards	6
1.2 Electrical Hazards	6
1.3 Installation	7
1.4 Operation	7
2. Package Contents.....	8
3. Wiring and Installation Procedures.....	9
3.1 Wiring.....	9
3.1.1 Electrical Connections	9
3.1.2 Wire Size	10
3.1.3 Grounding	11
3.1.4 Fusing	12
3.1.5 Stop Switch	12
3.1.6 System Wiring Diagrams	13
3.2 Mounting to Tower.....	18
3.2.1 Attaching to Pole	18
3.3 Hub and Rotor Assembly.....	19
3.3.1 Mounting Blades	19
3.3.2 Mounting Hub and Rotor	20
3.3.3 Attaching Nose Cone	20
3.4 Step-By-Step Instructions.....	20
4. Testing.....	22
4.1 General Discussion of Operation.....	22
4.1.1 Alternator	22
4.1.2 Voltage Regulator	22
4.1.3 Over-Speed Protection	22
4.1.4 Five Spinning Conditions	23
4.2 Bench Testing.....	24
4.3 Performance Testing.....	25
4.4 Adjusting the Internal Regulator.....	25
5. Trouble Shooting.....	26
5.1 Assembly.....	26
5.2 Electrical System.....	26
5.3 Elevation.....	27
6. Warranty Policy.....	28
7. Specifications.....	29
7.1 Technical Specifications	29
7.2 Performance Specifications	30
7.2 Sphere of Operation	31
7.3 Exploded View of <i>AIR-X</i>	31
8. Maintenance.....	32
9. System Requirements and Considerations.....	32
9.1 Batteries	32
9.2 Regulator Options	33
10. Siting.....	35
11. Towers.....	37
11.1 Guyed Towers	37
11.2 Roof Top Mounting	37
12. Frequently Asked Questions.....	39
13. Accessories.....	45
14. References.....	47

1. SAFETY PRECAUTIONS

The **AIR-X** has been designed with your safety in mind. However, there are inherent dangers involved with any electrical and/or mechanical equipment.

Safety must be the primary concern as you plan the location, installation and operation of the turbine. At all times be aware of electrical, mechanical and rotor blade hazards.

1.1 Mechanical Hazard

Rotating blades present the most serious mechanical hazard. The **AIR X's** rotor blades are made of very strong thermoplastic. At the tip, the blades may be moving at velocities over 275 miles per hour (440 km/hr). At this speed, the tip of a blade is nearly invisible and can cause serious injury. ***Under no circumstances should you install the turbine where a person could come in contact with moving rotor blades.***

CAUTION: DO NOT INSTALL THE TURBINE WHERE ANYONE CAN APPROACH THE PATH OF THE BLADES.

1.2 Electrical Hazards

The **AIR-X** is equipped with sophisticated electronics designed to provide protection from overcurrent electrical dangers. The internal electronics of the **AIR-X** prevent open circuit voltages from rising above 20 volts for 12-volt systems or above 40 volts for 24-volt systems. Please note that the inherent personal dangers from electrical current still exist, therefore caution should always be used when connecting this and other electrical devices.

Heat in wiring systems is often a result of too much current flowing through an undersized wire or through a bad connection. It is important to follow the wire-sizing chart in Section 3.1.2 on page 10 to insure a safe electrical system.

CAUTION: FOLLOW THE WIRE SIZING CHART IN SECTION 3.1.2 ON PAGE 10 TO HELP AVOID THE RISK OF AN ELECTRICAL FIRE.

Batteries can deliver a dangerous amount of current. If a short occurs in the wiring from the batteries, a fire can result. In order to avoid this threat, a properly sized fuse or circuit breaker is required in the lines connecting to the battery. Refer to Section 3.1.4 on page 12 for fuse sizing information.

CAUTION: FUSE ALL CONNECTIONS. FOLLOW THE FUSE SIZING GUIDELINES IN SECTION 3.1.4 ON PAGE 12 TO MINIMIZE THE RISK OF FIRE AND/OR AN ELECTRICAL FAILURE.

1.3 Installation

CAUTION: INSTALLATION PROCEDURES SHOULD BE PERFORMED AT GROUND LEVEL.

CAUTION: MAKE SURE THAT ALL BATTERIES ARE DISCONNECTED THROUGHOUT THE INSTALLATION PROCESS.

CAUTION: NEVER INSTALL THE **AIR-X** UPSIDE DOWN.

Please follow these precautions during the installation process:

- Choose a calm day.
- THINK SAFETY! Have someone available to help during the installation process.
- Disconnect batteries from turbine wiring.
- Prior to attaching the wires to the battery, tie the wind turbine output lead wires (*positive = red; negative = black*) together near the battery to be sure that the rotor will not spin-up during installation.

NOTE: Do not install the blade assembly until the turbine is mounted on the tower.

1.4 Operation

Check support structures, blades, and electrical systems on a regular basis.

- The rotor blades are very strong; however, if they come in contact with a solid object, they can break. Use common sense about safety when locating the turbine.
- When performing periodic inspections, or at anytime when you must approach the path of the blades, disconnect the power leads from the battery and tie the wind turbine output leads together to stop (*slow down*) the blades from rotating. The turbine can also be shut down through the use of a stop switch. Please refer to Figure 2 on page 12 on how to install a stop switch in your system.
- Please note that there is a short break-in period with new turbines. The bearings in both the turbine yaw and the turbine rotor will require approximately 60-100 hours of operation in normal wind speeds (approximately 18 – 20 mph, 8 – 9 m/s) before they are running at peak efficiency. During this break-in period, the turbine operation might appear sluggish.

CAUTION: NEVER APPROACH THE TURBINE DURING OPERATION.

USE COMMON SENSE AND PLEASE BE CAREFUL

2. PACKAGE CONTENTS

Compare the parts shown in Figure 1 to ensure that the contents of the box contain all necessary parts.

CAUTION: THE EDGES OF THE ROTOR BLADES ARE SHARP. PLEASE HANDLE WITH CARE.

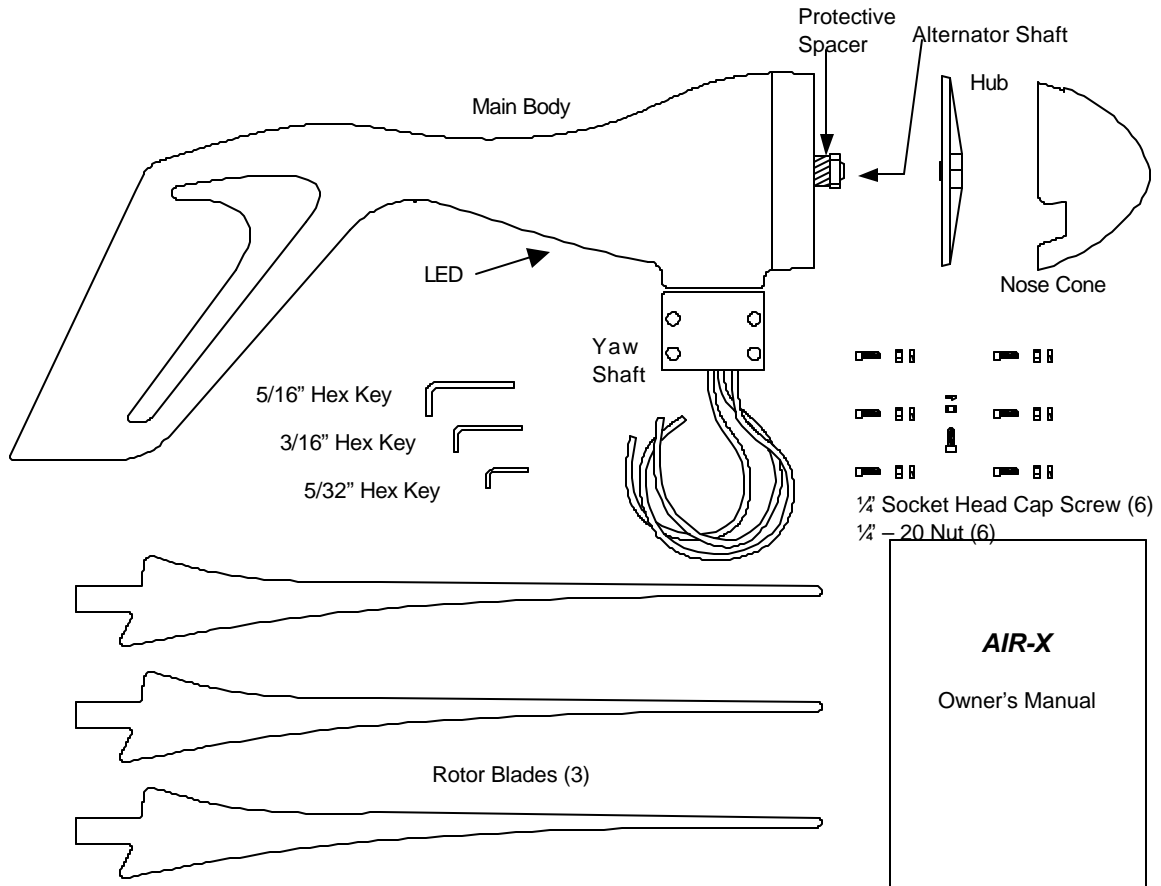

Figure 1

WARNING: THE AIR-X IS SHIPPED WITH A SPACER THAT PREVENTS THE ROTOR SHAFT FROM BEING PRESSED INTO THE TURBINE. WHEN INSTALLING THE HUB, **BE CAREFUL NOT TO PRESS THE ROTOR SHAFT INTO THE TURBINE.** DOING SO COULD DAMAGE THE CONTROL ELECTRONICS. ONCE THE HUB IS MOUNTED SECURELY, IT WILL HOLD THE ROTOR SHAFT IN A SAFE LOCATION. DO NOT REMOVE THE PROTECTIVE SPACER UNTIL YOU ARE READY TO MOUNT THE HUB TO THE TURBINE.

3. WIRING AND INSTALLATION PROCEDURES

Your **AIR-X** is shipped partially disassembled. Refer to Figure 7 on page 19 for assembly instructions. Please completely read all procedures before beginning installation.

NOTE: Do not install the blade/hub assembly until the turbine is mounted on the tower. Do not remove the protective spacer on the rotor shaft until you are ready to install the blade/hub assembly.

Required Tools:

- 5/16" hex key wrench (*included*)
- 3/16" hex key wrench (*included*)
- 5/32" hex key wrench (*included*)
- Torque wrench with 5/16", 3/16", and 5/32" hex drives (optional)
- Soldering iron or propane torch
- Rosin core solder
- Electrical tape or 1/4" (6-7mm) heat shrink
- Wire strippers
- Wire crimpers

3.1 Wiring

3.1.1 Electrical Connections

NOTE: Refer To All Local and National Codes Before Installation.

CAUTION: MAKE SURE THE TURBINE IS DISCONNECTED FROM THE BATTERIES DURING INSTALLATION.

Avoid connecting different metals together (i.e., copper and aluminum). This will cause a galvanic cell that will erode one of the metals. When such connections cannot be avoided, consult your dealer or an electrical supply house for anti-oxidant compounds. If possible solder wire termination ends.

CAUTION: CONNECTIONS SHOULD BE INSPECTED PERIODICALLY FOR SIGNS OF CORROSION AND CLEANED WHEN NECESSARY.

NOTE: All electrical power cables should be physically protected. Run the wires inside the tower or conduit for maximum protection.

NOTE: The yaw can support a total of 150 lbs. (68 kg) in wire weight. For higher wire weights, you must install a strain relief to minimize the stress put on the hanging wires. The average weight of copper wire is .323 lb/in³ or 8941 kg/m³. Use the table below multiplied by length multiplied by the number of wires to calculate the approximate weight of your wiring system.

AWG SIZE	14	12	10	8	6	4	3	2	1	0	2/0	3/0	4/0
X-Section Area [in ²]	0.004	0.005	0.008	0.013	0.021	0.033	0.041	0.052	0.069	0.083	0.105	0.132	0.166
X-Section Area [mm ²]	2.68	3.31	5.26	8.37	13.3	21.1	26.7	33.6	44.2	53.5	67.4	85.0	107

Wire Color Codes
RED = positive
BLACK = negative
GREEN = earth ground

3.1.2 Wire Size

To select the appropriate size wire, measure the distance from the batteries to your **AIR-X**, then refer to the following wire sizing chart as *minimum* sizes. If cost is not an issue, a larger sized wire will improve the performance of your **AIR-X**.

All electrical systems lose energy from the resistance of the wires used. Larger wiring sizes have smaller losses, but can be considerably more costly. The following wiring sizes provide maximum annual energy losses of 5% or less for sites with a 12mph average wind speed (assuming the standard Rayleigh distribution of wind speeds,) which is sufficient for most sites. If you know your average wind speed to be different, compensate the wiring LENGTHS given in the charts using the factors given at the end of this section. Table entries with a “*” denote cases which should use additional bus lines.

We recommend these as the *minimal* wire sizes; for optimal performance you should use the largest wires that are practical and affordable. Local, state, and national electrical codes supercede these recommendations, and should be followed to insure the safety of your system.

12V AIR-X: Wire Size, Considering 12mph (5.2 m/s) Wind Average and 95% Energy Transmission Efficiency. Wire Size: AWG / sq mm

# Turbines	0-30ft	30ft-60ft	60ft-90ft	90ft-150ft	150ft-190ft	190ft-250ft	250ft-310ft	310ft-390ft	390ft-500ft
1	8g/8	6g/13	4g/21	2g/34	1g/53	0g/53	00g/67	000g/85	000g/85
2	6g/13	4g/21	1g/44	00/67	000g/85	0000g/107	*	*	*
3	4g/21	2g/34	0g/53	000g/85	0000g/107	*	*	*	*

Fuse: 50 Amp Slow-Blow per turbine

* If your system requires this length of wire, consider using additional, parallel wire(s).

24V AIR-X: Wire Size, Considering 12mph (5.2 m/s) Wind Average and 95% Energy Transmission Efficiency. Wire Size: AWG / sq mm

# Turbines	0-30ft	30ft-60ft	60ft-90ft	90ft-150ft	150ft-190ft	190ft-250ft	250ft-310ft	310ft-390ft	390ft-500ft
1	14g/2.7	12g/3.3	10g/5.3	8g/8	6g/13	4g/21	4g/21	4g/21	2g/34
2	12g/3.3	8g/8	6g/13	4g/21	4g/21	2g/34	2g/34	1g/44	0g/53
3	10g/5.3	8g/8	6g/13	4g/21	2g/34	2g/34	1g/44	0g/53	00g/67

Fuse: 30 Amp Slow-Blow per turbine

Wiring Compensation for Average Wind Speed

For different average wind speeds, the wire LENGTHS in the charts should be compensated. Compensating by changing wire gauge can lead to safety problems. For the average wind speed of your site, multiply each wire length in the chart by the factor shown:

Average Wind Speed	Multiplier for Wire LENGTHS
9mph / 4m/s	2
10mph / 4.5 m/s	1.5
11mph /4.9 m/s	1.25
12mph / 5.4 m/s	1
13mph / 5.8 m/s	0.8
14mph / 6.3 m/s	0.6

Wiring Resistance and Regulation

Depending on your exact system configuration including other charging sources in your system, wiring resistance may affect the regulation set point of the turbine. Higher wiring resistance (smaller wires) will tend to lower the voltage at which the turbine enters regulation and stops charging. The recommended wiring sizes should provide little effect on the regulation set point, but all installations should be observed over time to ensure that the batteries are charged to the proper voltage.

3.1.3 Grounding/Lightning Protection

Properly grounding the turbine is very important in protecting the electronics for long-term operation. Grounding procedures must be followed along with any local electrical codes.

IMPORTANT: SEVERE TURBINE DAMAGE CAN RESULT FROM IMPROPER GROUNDING! FAILURE TO PROPERLY GROUND WILL VOID YOUR WARRANTY.

It is very important to ground your battery bank and ground your tower for lightning and static protection. Proper grounding also enhances the safety of your turbine system. The green lead wire provides grounding for the body of the turbine. This wire must be connected to the system earth ground. This is usually done by connecting a wire from a ground rod near the base of the tower to the green turbine lead wire. For additional lightning and static protection, another wire should connect this ground rod to the tower pipe.

The negative wire of your system should also be connected to a ground. This is usually done by connecting a wire from the negative battery terminal to a nearby ground rod. Wires with the same ratings as the positive and negative wires must connect all system grounds (see Wire Size Section 3.1.2).

A ground electrode can be made for systems without an existing system ground from an 8 ft. (2.4 m) section of 3/4" (19 mm) galvanized pipe or conduit, or an 8 ft. (2.4 m) section of 5/8" (16 mm) iron or steel rod. This ground electrode must be buried completely beneath the soil, at no more than 45 degrees from vertical, or horizontally at least 2 1/2 ft. (75 cm) beneath the surface. It is recommended that the ground electrode be installed as close as possible to the batteries for maximum lightning protection. The base of the tower is also a good location for an appropriate surge arrester.

Delta manufactures surge arrestors for lightning protection, such as their model LA 302-RG. Contact: Delta Lighting Arrestors P.O. Box 750, Big Springs TX 79721, Phone (915) 267-1000 Fax (915) 267-1035 or your dealer for more information.

3.1.4 Fusing

The **AIR-X** is capable of producing high amperages. As with all electrical installations, you must protect each of your turbines with a properly sized fuse or circuit breaker. The **AIR-X** should be wired with an appropriately sized “slow-blow” type fuse between itself and the batteries. If a stop switch is used, the fuse should be placed between the switch and the batteries.

Recommended Size for Circuit Breakers or Slow-Blow Fuses

- 12-volt model: 50 amps D.C.
- 24-volt model: 30 amps D.C.

3.1.5 Stop Switch

Southwest Windpower recommends the use of a stop switch with your **AIR-X** to provide a convenient method for shutting down the turbine. A 50-amp single-pole double-throw switch will work as a stop switch for most applications. These switches are available from Southwest Windpower and should be wired as shown in Figure 2. The switch disconnects the battery and then shorts the turbine wires causing the turbine to stop spinning (in high winds the blades will spin slowly). Shorting the turbine will not cause any damage or additional wear. The stop switch model offered by Southwest Windpower is sufficient for most systems, but it should not be used in applications where a code compliant switch is necessary, or for 12V turbines used in very high wind applications.

NOTE: The center post must be positive from the turbine. Outside posts can be swapped as either battery positive or battery/turbine negative.

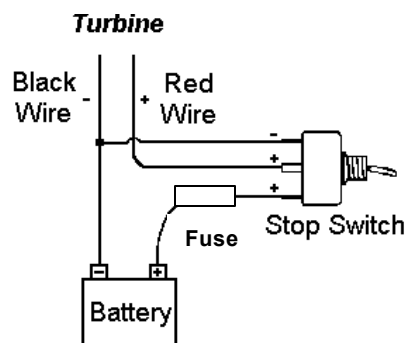

Figure 2 Stop Switch Wiring

If you need a code compliant switch and the voltage of your turbine is 24V, then contact Schott Applied Power and purchase the AIR 403 shutoff/circuit breaker combination. This code compliant switch entails a pair of interlocked 60-amp breakers that work as both a stop switch and a circuit breaker for your turbine. Be sure to follow the installation instructions from Schott Applied Power. Their part number for this switch is 10-160-003 and they can be reached at 800-777-6609.

If you need a code compliant switch and the voltage of your turbine is 12V, or you have a 12V turbine being used in a very high wind application, then please contact Southwest Windpower for an appropriate switch. Southwest Windpower will be able to recommend the best switch for this application.

3.1.6 System Wiring Diagrams

Before deciding how to wire your **AIR-X** it is important to understand how your existing system is wired and how the **AIR-X's** internal regulator operates. Refer to the General Discussion of Operation in Section 4.1.2 on page 22 for information on the **AIR-X's** internal regulator.

The recommended way to connect the turbine to your battery bank is to wire the turbine directly to the battery bank to its own set of battery posts. This will allow the turbine to operate independently. The **AIR-X's** internal regulator will independently monitor the battery and charge as necessary.

You can wire the **AIR-X** through most "power centers". However, if you experience interference or pre-regulation, you must bypass it and wire the turbine directly to the battery bank.

Some external charging sources (*i.e. solar panels, fuel-powered generators, additional wind generators etc.*) can interfere with the turbines electronics and cause pre-regulation. If there is external interference, it will not harm the turbine: it will just cause the turbine to spin slowly as if "braked" or in the stop position. If this occurs, test the possible interference by disconnecting the other charge sources to determine the possible interference source.

Choose the appropriate suggested wiring diagram below for proper wiring information.

A. Single AIR-X Wiring

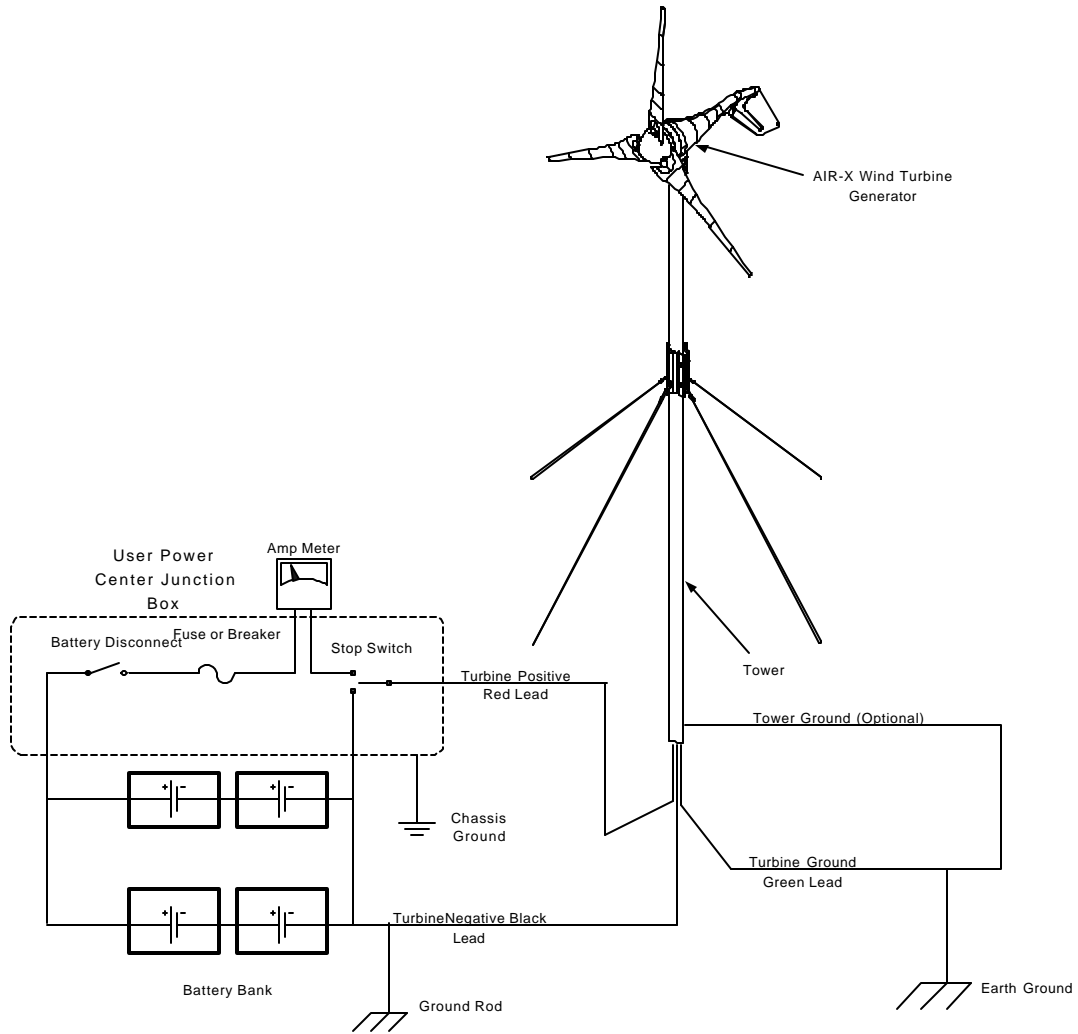

Figure 3

B. Single AIR-X Wiring (UL Recommended Configuration)

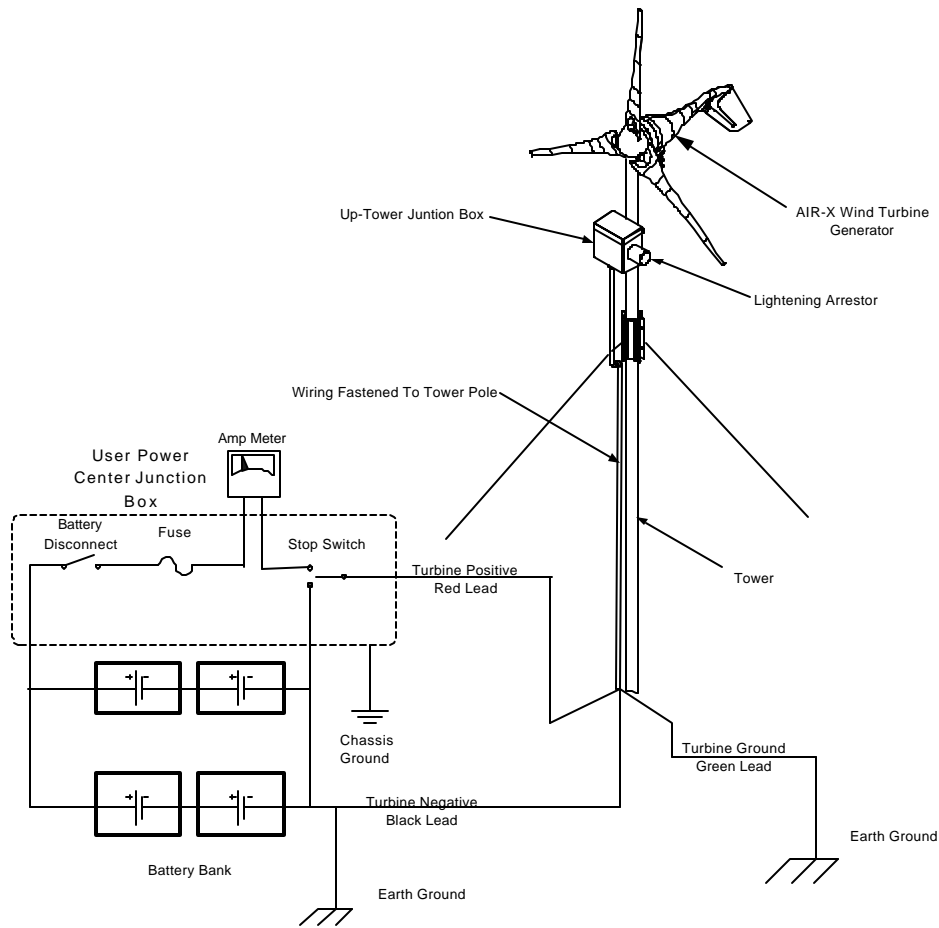

Figure 3-A

NOTE: This configuration includes an up-tower junction box for UL compliance. For additional questions regarding this configuration contact Southwest Windpower

C. AIR-X In a System With Solar Panels (Hybrid System)

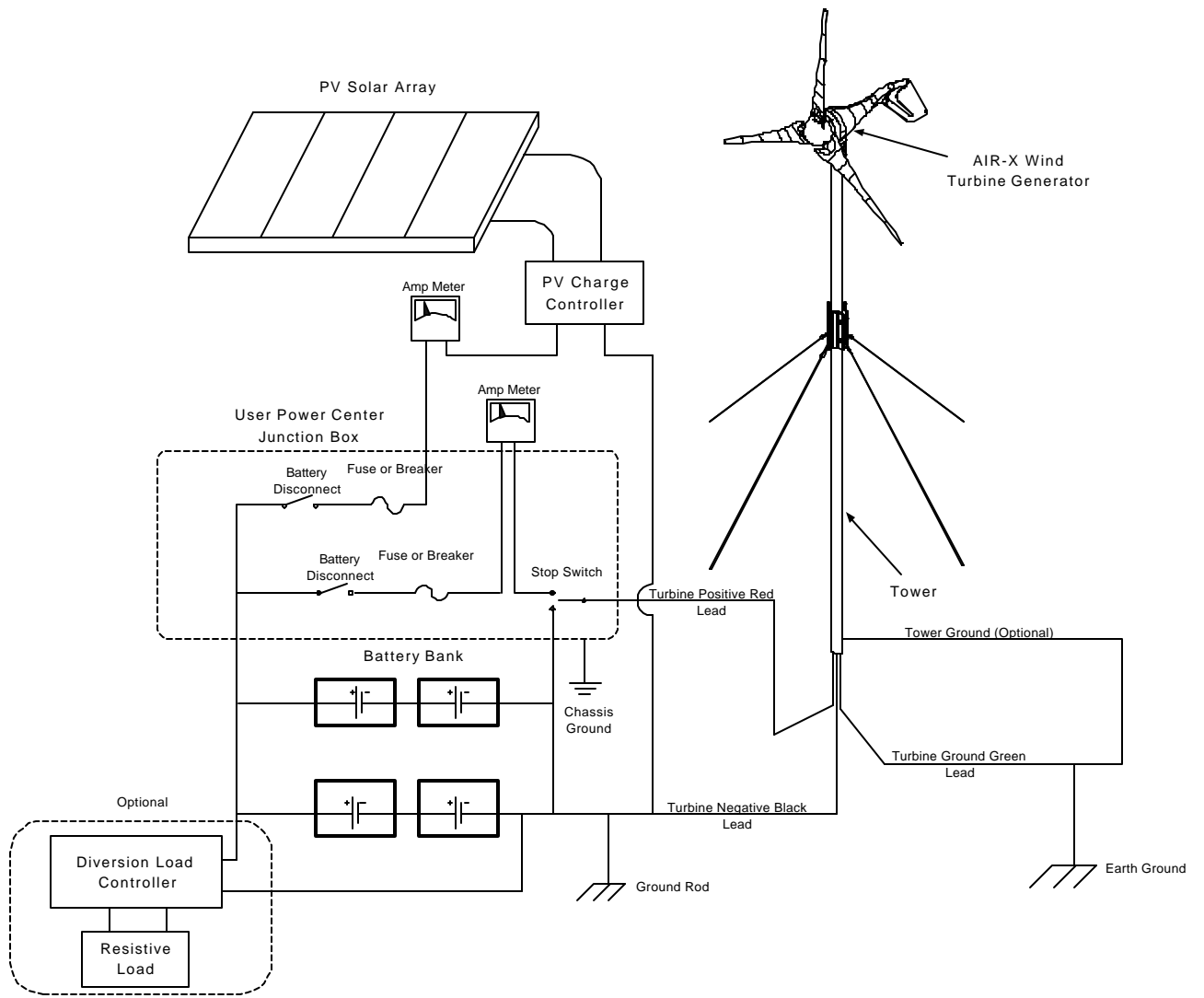

Figure 4

NOTE: In this drawing the *AIR-X's* internal regulator is used. A diversion type external regulator can also be used. The diversion type regulator could be used in any of the systems.

D. Multiple AIR Installation

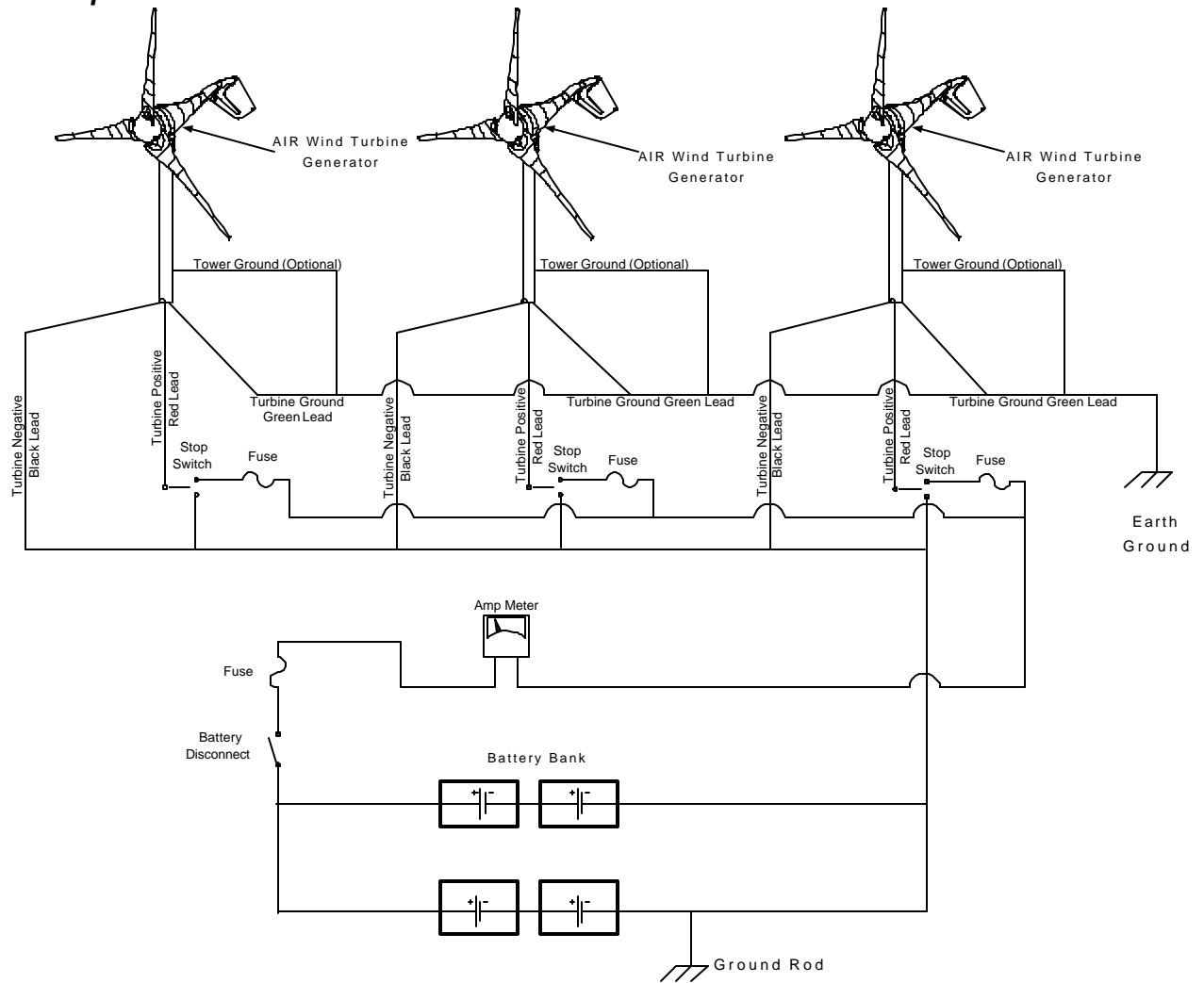

Figure 5

There are two methods to wire multiple **AIR** wind turbines.

a) Each Turbine Wired Directly To Battery

Each turbine operates as an independent system separate from other solar panels, gas generators or any other battery charging sources. If the turbine has its own fuse, stop switch (*optional*), and wires, the turbine is able to individually communicate and charge the battery.

b) Each Turbine Wired To A Bus Bar

If you plan to wire two or more turbines to a “bus”, and then run one set of wires from the bus to the battery, you can use each turbine’s internal regulator or install an external regulator. If you use an external regulator use a diversion style regulator that turns excess power into heat for heating a room, water etc. When wiring multiple turbines, it is possible to reduce your wiring costs by using a bus bar system.

NOTE: Do NOT accidentally connect the turbine “backwards” to the battery for even a second (i.e. turbine positive to battery negative and turbine negative to battery positive). Doing this will damage the circuit inside the turbine and void your warranty.

3.2 Mounting To Tower

The **AIR-X** is designed to be mounted on tubing or pipe with a 1.875 inch (48mm) outside diameter. This is equivalent to 1 ½inch SCH 40 pipe, which can be used in some tower applications. There is a soft coupling inside the yaw shaft mount that is designed to provide a secure fit and to dampen some of the noise transmitted down the tower. The pole must be mounted with hardware specifically designed for small wind turbines. Southwest Windpower offers a complete stand-alone tower package and a “Roof Mount Kit” for mounting to structures, which provides secure mounting and superior noise isolation. Contact your dealer for details.

CAUTION: Use only properly sized metal pipe for towers.

3.2.1 Attaching to Pole

While attaching the turbine to the tower, be careful not to pinch the yaw wires. Slide the yaw all the way down over the end of pole. After the yaw is seated on the pole, move it back up a 1/8th inch (2mm) to prevent the bottom of the yaw from contacting the top of the pole. This way the only contact between the tower and yaw is through the rubber pad, which will reduce noise transmission. Tighten all mounting fasteners to 3 - 5 foot lbs. (4.1-6.8 N.m.).

Make sure that your tower allows for proper clearance of the blades. A minimum 2-inch (20 mm) clearance must be given between the blade tips and any obstructions. Refer to Figure 6 below, and the “Sphere of Operation” drawing in Section 7.3 on page 31 for proper clearances.

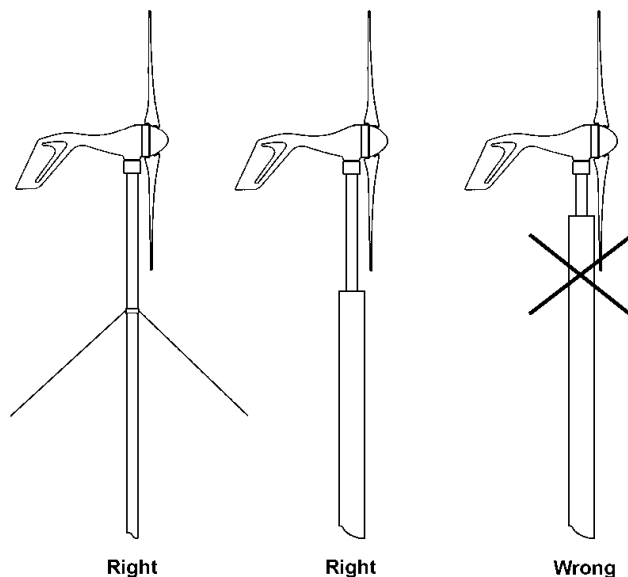

Figure 6 Proper Blade-to-Tower Clearances

3.3 Hub And Rotor Assembly

Before assembling the hub and rotor refer to *Figure 7* below, and the following detailed instructions.

NOTE: To avoid damage to the blades during installation, do not put the blade/hub assembly on the turbine until the turbine is mounted on the tower.

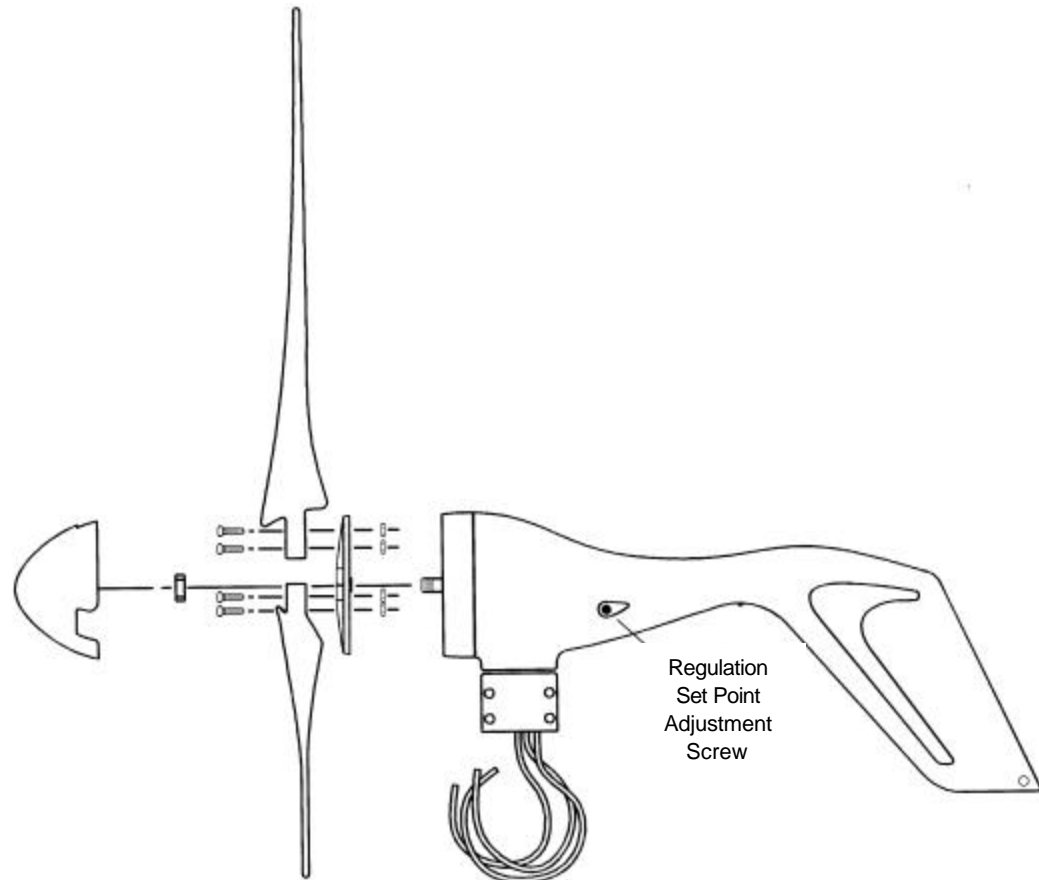

Figure 7

NOTE: DO NOT PRESS THE ROTOR SHAFT INTO THE TURBINE WHEN MOUNTING THE BLADE ASSEMBLY.

3.3.1 Mounting the Blades

CAUTION: THE EDGES OF THE ROTOR BLADES ARE SHARP. PLEASE HANDLE WITH CARE.

Notice that the screw holes in the blades are counter-bored for the socket head cap screws. Place one of the blades with the counter bore facing up, and align the screw holes. Insert one of the socket head cap screws through the blades and hub. Place a nylock self-locking nut on the end of the screw and tighten the screw with the 3/16" hex key wrench to 8 - 10 foot lbs. (10.8 – 13.6 Nm). Repeat this procedure on all three blades. Do not over-torque. Please

note that over-torque of blades may cause damage to the blade and compromise the safety of the product.

NOTE: TORQUE THE BLADE BOLTS TO 8 – 10 FOOT-LBS (10.8 – 13.6 Nm). DO NOT OVER-TORQUE.

NOTE: You may need to “thread” the screws through the hub with the hex wrench.

3.3.2 Mounting the Hub and Rotor

CAUTION: THE BLADES ARE SHARP. USE CAUTION WHILE HANDLING THE BLADES.

Remove the 5/8” nut and protective spacer from the alternator shaft. Carefully slide the blade assembly onto the alternator shaft. Place the nut on the shaft and thread the nut on by spinning the blade assembly. Insert the 5/16” hex key torque wrench into the alternator shaft and tighten the nut by holding the hub set and tightening the shaft with the torque wrench. The nut should be tightened to 50 - 65 foot pounds (68 – 88 Nm). When the blade set assembly is tightened, spin it to be sure it turns freely. While mounting the blade assembly to the turbine, be careful not to push the rotor shaft into the turbine.

3.3.3 Attaching Nose Cone

Carefully place the nose cone over the center of the hub and the blades. Snap the nose cone into place. Be sure all three edges catch. Check to see that the nose cone is secure by firmly pulling on it. The nose cone does not affect the performance of the turbine and may be left off, if desired.

3.4 Step-By-Step Instructions

The following *Step-By-Step-Installation-Procedures* provides you with an outline of the **AIR-X** installation process. This consolidated reference should only be used as an outline during installation. Refer to the appropriate sections for further details.

- 1) Run the wires from the battery (do not connect to the battery), through the pole to the top of the tower. **Be sure not to connect the wires to the battery until everything else has been completed.**
- 2) Strip the insulation back from each set of wires.
- 3) Mark both ends of all the wires with tape to identify which is negative, positive and earth ground.

AIR-X color-codes:
RED = Positive
BLACK = Negative
GREEN = Ground.

- 4) Connect the wires from the **AIR-X** to the wires running to the battery.
- 5) Insulate the connections using either heat shrink tubing or a quality electrical tape.

CAUTION: IF THE WIRES ARE HOOKED-UP BACKWARDS YOU WILL DAMAGE THE **AIR-X's** ELECTRONICS. (IF YOU ARE UNCERTAIN OF THE POLARITY OF THE WIRES, SIMPLY SPIN THE ROTOR SHAFT AND MEASURE THE VOLTAGE DIRECTION WITH A VOLT METER).

6) Once the wires are attached to the **AIR-X**, gently pull the wires down through the tower sliding the yaw shaft over the 1 1/2", Schedule 40 steel pipe (*Actual OD 1.875 inches, 48mm*). Do not use plastic pipe.

7) Slide the yaw shaft all the way down over the end of pole being careful not to pinch the yaw wires. Be sure to leave enough slack in the wires so that if necessary, the turbine can be removed.

8) After the yaw is all the way onto the pole, move it back up 1/8th inch (2 mm) to prevent the bottom of the yaw from contacting the top of the pole. The only contact between the tower and yaw is through the rubber pad which will reduce the transmission of noise down the tower.

9) Once the yaw shaft is on the tower, firmly tighten the yaw clamp screws with the 5/32 hex key to 3 – 5 foot pounds (4.1 - 6.8 Nm). The **AIR-X** should yaw freely without restrictions.

10) Check your **AIR-X** to be sure that it is securely attached to the mounts. Remember that this attachment will have to hold in high winds.

11) Remove the nut and protective spacer on the rotor shaft, and carefully attach the assembled hub and blades to the rotor shaft without pushing the rotor shaft into the turbine.

12) Run all wires from the turbine to the battery (do not connect wires to the battery). Be sure to crimp and solder the connections using the appropriate sized connectors. If you plan to connect an amp meter into your system, see Figure 3 on page 14.

13) Attach your positive (RED) wire to a fuse. Refer to Section 3.1.4 for fusing information.

14) Make sure that your system is properly grounded before proceeding. Refer to the Grounding Section 3.1.3 on page 11.

IMPORTANT: SEVERE UNIT DAMAGE MAY RESULT FROM IMPROPER GROUNDING. FAILURE TO PROPERLY GROUND THE TURBINE WILL VOID YOUR WARRANTY.

15) Before attaching the wiring to the battery, make sure that:

- All circuit breakers are in the off position
- The stop switch is in the "stop" or shorted position (if installed)

16) Attach wires to the battery. Red wire to positive, Black wire to Negative.

17) Turn on the circuit breakers and or stop switch.

18) When the AIR-X is first connected to the battery bank, the microprocessor will blink the LED twice to indicate that the control circuit is running correctly. Once the blades reach 500 RPM, the turbine will begin charging and the LED will turn on. The LED can be difficult to see during the day.

19) You have now completed the installation process.

4. TESTING

4.1 General Discussion of Operation

The available energy in the wind scales with the cube of the wind speed. This means that each time you double the wind speed you get eight times the power. The unique design of the **AIR-X** is such that it can take full advantage of the power in the wind. The efficiencies of other wind turbines are usually linear and cannot take advantage of the cube effect of the wind. These turbines are efficient at only one or two points along the power curve. The **AIR-X** controller uses peak power tracking to match the efficiency curve of the turbine with the available energy in the wind, making it efficient all along the curve. This is an important reason why the **AIR-X** is able to provide you with such a large amount of power from a small turbine. The peak power tracking works by continually adjusting the loading of the alternator to keep the blades running at their optimal angle of attack at all wind speeds. The result is high blade efficiency and lower blade noise throughout the power curve. The control is managed by the **AIR-X's** microprocessor.

4.1.1 Alternator

The **AIR-X** uses a three-phase brushless permanent magnet alternator. The electronics internally rectify the power to D.C. The rotor is comprised of 12 Neodymium Iron Boron arced magnets, the most powerful magnet material available. The alternator was designed simultaneously with the new control electronics to provide efficient power generation throughout the operating range.

4.1.2 Voltage Regulator

The **AIR-X** continually monitors the battery voltage and compares it to the regulation set point. The regulation set point is field adjustable, and is factory set to 14.1V (12V Turbine) or 28.2V (24V System). When the battery voltage rises above the set point, the turbine enters regulation mode. During regulation mode, the turbine automatically shuts off. It stops rotating, and no power is generated. Before entering regulation mode, the **AIR-X** will momentarily stop charging in order to get a true reading of the battery voltage. If the turbine was sensing a high voltage due to line loss in the system, this will be detected and the **AIR-X** will continue to charge. This process takes a fraction of a second and will not be visible.

Once in regulation mode, the **AIR-X** will simply wait for the battery voltage to drop. Normal charging will resume when the battery voltage drops slightly below the fully charged level. For 12v turbines the turbine will resume charging at 12.75V (25.5V for 24V turbines). The **AIR-X** controller will blink the 10 times each second (fast blink) to indicate that it is in regulation mode.

NOTE: Bad connections, undersized wires, and inline diodes will cause the internal regulator to not work properly. It is very important that the **AIR-X** can "sense" the proper battery voltage.

4.1.3 Over-speed Protection

All wind turbines must have some form of over-speed protection in order to survive high winds. Most small wind turbines rely on a mechanical method of bending or tilting out of the wind. The **AIR 403** was unique in using aero-elastic twist or blade “flutter” for over-speed protection. The flutter design had the advantage of simplicity and reliability, but had the strong disadvantage of noise. The **403’s** blades generate an objectionable noise when in flutter.

The **AIR-X** also uses stall control of the blades, but the stall mode is activated by the controller before the flutter RPM is reached. The result is a dramatic reduction in RPM in wind speeds above 35 mph. The stall mode of the AIR-X reduces wear on the blades and bearings in high winds, and most importantly, it protects the turbine from damage from high winds. It does this quietly, *without* producing the flutter noise of the **AIR 403**.

Stall mode is activated at about 35 mph (15.6 m/s), and will stay in effect until the wind speed drops below 32 mph (14.3 m/s). If the **AIR-X** senses wind speeds above 50 mph, it will shut down completely for 5 minutes. The **AIR-X** controller will blink the LED two times each second (slow blink) to indicate that it is in stall mode.

4.1.4 Five Spinning Conditions of the AIR-X

a) Open Circuit

When the turbine is disconnected from the batteries, it will “free-spin”. In this mode the generator can spin “unloaded” with the wind. The internal regulator has a high-speed regulation to protect the circuit from high voltage conditions. However, when a high voltage condition is sensed, the turbine is stopped which causes the voltage to drop and the high voltage condition to end. The result is an oscillating mode which is not recommended.

Operating the turbine in open circuit for a brief period of time will not damage the turbine. However, operating the turbine in open circuit for a long period of time can cause excessive wear to the turbine and is NOT recommended. We recommend that during long periods of operation the turbine should be connected to a battery or the turbine wires should be shorted. Shorting the turbine will minimize wear to the bearings and prolong turbine life and is quieter than running open circuit.

b) Normal Operation (Charge)

When the generator is connected to a battery bank in need of a charge, the turbine blades will spin “normally” with the wind. The turbine will charge the battery bank as necessary until the battery voltage matches the regulation set point.

NOTE: When switched from open circuit to charge, you may notice a reduction in RPM as the generator is now “under load”. If the batteries are fully charged the turbine blades will slow to a silent spin.

When charging, the **AIR-X** Controller will turn on the LED.

c) Regulation

When the battery voltage matches the regulation set point, the turbine will go into “regulation”. Blade RPM will lower dramatically (to almost zero RPM) and output will stop. Normal charging operation will resume when the battery voltage drops slightly below the fully charged level. This regulation feature called Hysteresis is explained in more detail in the **New Features** section (see page 4).

In regulation mode, the **AIR-X** controller will blink the LED 10 times each second (fast blink).

d) Stall Mode

Stall mode is the over-speed condition described in section 4.1.3. In stall mode, the RPM will drop between 500 and 700 RPM, depending on the exact wind speed. Above 50 mph, the turbine will shut off completely and the RPM will slow to almost zero.

In stall mode, the **AIR-X** controller will blink the LED two times each second (slow blink).

e) Braking

Braking can be accomplished by directly shorting the turbine negative and positive wires or through the use of a Stop Switch. The Stop Switch will disconnect the turbine from the battery, and then short the positive and negative leads from the generator together.

The blades could still spin slowly but will not charge the battery.

4.2 Bench Testing

Three quick bench tests can verify if your **AIR-X** is working correctly. Test 1 does not require any equipment. For tests 2 and 3 you will need your battery bank and a power drill. Because of the voltage boosting circuitry in the **AIR-X**, the open circuit voltage test that is performed on the **AIR 403** is not easy to interpret on the **AIR-X**, and is not recommended.

Test 1

1. Remove blade assembly from turbine and place in a safe location. (*Do not stand the blade assembly against a wall.*)
2. Spin rotor shaft with your fingers or the allen wrench provided while at the same time connecting and disconnecting the Red and Black yaw wires. (Be careful not to press the rotor shaft into the turbine body.)
3. With the yaw wires connected, the rotor shaft should become more difficult to rotate and feel "lumpy". With the yaw wires disconnected it should spin freely. If these conditions do not exist, you should contact your turbine dealer or Southwest Windpower.

Test 2

1. Remove blade assembly from turbine and place in a safe location. (*Do not stand the blade assembly against a wall. Do not press the rotor shaft into the turbine body.*)
2. Connect the turbine power wires to the appropriate terminals on your battery: RED= Positive, BLACK = Negative.
3. Each time the **AIR-X** is connected to a battery, the LED will blink two times to indicate that the controller is running properly. You may need to wait 10 seconds between iterations of this test in order to let any internal voltage drain. If the LED does not blink when the **AIR-X** is connected to a battery, you should contact your turbine dealer or Southwest Windpower.

Test 3

1. Leave the **AIR-X** connected to your battery bank. With a 5/16" hex drive in an electric drill, spin the rotor shaft while observing the LED. (*Cut a small piece off of the Hex Key provided if necessary.*) **Be very careful not to push in on the rotor shaft while performing this test. Doing so could damage the control electronics.**
2. Below 500 RPM, the rotor should spin freely and the LED should remain off.

3. At 500 RPM and above, the **AIR-X** should be charging the battery. You should begin to feel some resistance on the rotor shaft and the LED should turn on. The shaft should have a slight resistance to rotation, but should still rotate fairly easily. If the shaft is cogging (difficult to rotate), contact your turbine dealer or Southwest Windpower. Be sure your battery voltage is not high enough to activate the regulation mode during this test.

4.3 Performance Test

1. *Isolate the turbine from the system.*

Connect red positive turbine wire to the battery positive post. Connect the black negative turbine wire to the negative battery post. Make sure no other system charging components are connected. Also, make sure that switches, diodes, regulators or meters are not connected.

2. *Connect amp meter.*

Connect your non-averaging amp meter in-line with the positive (*red*) wire according to the manufacturer's recommendations.

3. *Monitor wind speed vs. output*

Record the data and compare to the power curve. Use an anemometer located within 5 feet (1.5 m) of the turbine to get accurate wind speed information. An anemometer located in a higher location will not provide correct information for power curve assessment. Also refer to the elevation vs. output chart in Section 5.3 on Page 24 for information on elevation's effect on output. Small differences in the wind can have substantial effects on output.

4. *Check results*

If the turbine has very poor or no output when compared to power curve, refer to the Trouble Shooting section.

4.4 Adjusting the Internal Regulator

It is important to understand how to use the **AIR-X's** internal electronics to ensure proper charging of your batteries. Refer to Figure 7 on page 19 for the location of the regulator adjusting screw. In the following paragraphs 24-volt settings are in *Italics*.

The voltage regulator is factory set at 14.1 (*28.2*) volts. The factory setting is marked on the casting with a small indentation aligned with the screw slot.

To change the setting on the voltage regulator, rotate the adjusting screw 1/8 of a turn for each 0.42 (*0.85*) volt change desired. For example, if you want to set your voltage regulator to 14.52 (*29.05*) volts, turn the adjusting screw clockwise by 1/8 turn, from the 14.1 (*28.2*) volt setting.

The adjustment screw will provide regulation settings for voltage ranges at least as wide as those listed below. The actual voltage set point at the extreme counter-clockwise position may be as much as 10% lower than the value listed, and at the extreme clockwise position may be up to 10% higher than the value listed.

AIR-X Adjustable Voltage Range

12v 13.6v to 17.0v preset to 14.1v
24v 27.2v to 34.0v preset to 28.2v

READ THIS BEFORE YOU CONSIDER ADJUSTING THE REGULATION SETPOINT

Turning “up” the regulation set point adjustment will **NOT** increase the *AIR-X's* output voltage or amperage. It simply adjusts the “shut down” point for the generators’ voltage regulator. When the battery voltage reaches the regulation set point voltage, the turbine will slow down and stop charging the batteries. Turning the screw completely clockwise will **NOT** increase the voltage or power output and will only increase the probability of overcharging your batteries.

5. TROUBLE SHOOTING

If the turbine does not work properly after following the installation instructions, then read this chapter and carefully compare your installation with each section.

5.1 Assembly

Make sure the blade assembly is on tight. You can check by placing the 5/16” hex key in the shaft, holding it and attempting to turn the blade assembly. If you can turn the blade, retighten the blade assembly.

To minimize noise, make sure that you have loosened the four mounting screws and moved the turbine up 1/8” inch (2mm) and then re-tighten the screws. This will prevent the top of the pole from touching the aluminum in the yaw shaft assembly.

5.2 Electrical System

Measure the voltage at the battery terminals to which the *AIR-X* is connected. For the factory regulation set point, if the voltage for a 12v system reads 14.1V or higher (24v 28.2), then the turbine will sense the battery is charged and stop producing power.

NOTE: THE *AIR-X* ELECTRONICS INCLUDE INTERNAL DIODES. DO NOT PUT ADDITIONAL BLOCKING DIODES IN BETWEEN THE *AIR-X'S* WIRES AND THE BATTERIES. ANY DIODES BETWEEN THE TURBINE AND THE BATTERIES WILL PREVENT THE TURBINE FROM PROPERLY “SENSING” THE BATTERIES.

While you are conducting output tests, make sure no other devices such as alternators or photovoltaic panels are charging the batteries at the same time. The total voltage from other charging sources could increase the battery voltage causing the *AIR-X's* regulator to think the batteries are charged and prematurely stop charging.

It is a good idea to connect the wires from the *AIR-X* to separate battery terminals on the battery bank to ensure the turbine reads the battery voltage instead of output voltages from other charging sources. Higher input voltages from solar panels can trick the *AIR-X* into thinking the battery is charged.

Also, check the condition of each individual battery. One bad battery can create high voltages (16-18 volts) and stop the turbine from charging. Consult the battery manufacturer for testing individual batteries or cells.

5.3 Elevation

An important fact to keep in mind is elevation. The higher a wind generator is from sea level, the lower the air density. Air density is directly proportional to the output of your turbine. Here are some general numbers to keep in mind when determining the maximum output that can be expected from a wind turbine.

1-500 ft	(0 – 150 m)	100%
500-1000 ft	(150 – 300 m)	97%
1000 - 2000 ft	(300 – 600 m)	94%
2000 - 3000 ft	(600 – 900 m)	91%
3000 - 4000 ft	(900 – 1200 m)	88%
4000 - 5000 ft	(1200 – 1500 m)	85%
5000 - 6000 ft	(1500 – 1800 m)	82%
6000 - 7000 ft	(1800 – 2100 m)	79%
7000 - 8000 ft	(2100 – 2400 m)	76%
8000 - 9000 ft	(2400 – 2700 m)	73%
9000 - 10,000 ft	(2700 – 3000 m)	70%

SUMMARY OF TIPS:

- Make sure there are no diodes in the line between the **AIR-X** and the battery.
- Make sure the amp meter is hooked up properly and that it is the proper type.
- Digital hand held meters work best for testing. They usually have a 10 or 20 amp DC scale, which is adequate, unless high winds are present.
- Make sure your amp meter is not an averaging style.
- If you are using an external regulator, be sure that the adjustment screw on the **AIR-X** is turned all the way clockwise.
- Make sure you are measuring the current through the positive wire. If you measure the current through the negative wire, you may only measure part of the current; the other part may travel through the ground connection.
- External regulators should be “diversion load” types.
- Use accurate wind speed information. Small differences in wind speed will have large effects on output.
- Make sure your stop switch is properly installed
- Make sure you do not have any electrical shorts in the system

6. WARRANTY POLICY

What Is Covered And For How Long

For turbines that are three years old or less from date of original purchase or three years and three months from date of build, any defective part will be replaced at no charge. Either a Southwest Windpower technician or an Authorized Service Center determines a defective part.

What Is Not Covered

- Damage due to lightning
- Damage due to extreme winds (110 MPH+; 60 m/s)
- Damage due to improper installation (including to but not limited to poor tower design & inverted hanging)
- Damage due to improperly wiring to batteries
- Blade damage resulting from contact with flying debris

Limitations And Exclusions

- 1) No one has the authority to add to or vary this limited warranty, or to create any other obligation in connection to Southwest Windpower and its products.
- 2) ANY IMPLIED WARRANTY APPLICABLE TO SOUTHWEST WINDPOWER'S PRODUCTS IS LIMITED IN DURATION TO THE SAME PERIOD OF TIME AS THIS WRITTEN WARRANTY.
- 3) SOUTHWEST WINDPOWER SHALL NOT BE LIABLE FOR INCIDENTAL, CONSEQUENTIAL, SPECIAL, OR CONTINGENT DAMAGES THAT ANY PERSON OR PROPERTY MIGHT SUFFER AS A RESULT OF ITS BREACH TO THIS WRITTEN AND OR IMPLIED WARRANTY.
- 4) This warranty applies to the original purchaser and may be transferred.

The Customer's Responsibilities

All of Southwest Windpower's products must be installed and operated in accordance to the owner's manual and local codes. Any modifications to the turbine design will void the warranty and compromise the safety of the machine.

You should keep a copy of the invoice or canceled check to verify the purchase date.

You will be responsible for shipping the turbine to the repair center if necessary.

If You Experience A Problem With Your Southwest Windpower Product

Contact your nearest authorized service center or Southwest Windpower to determine the nature of the problem.

Either Southwest Windpower or the Authorized Service Center will issue a return authorization number to return the turbine, or send you the replacement parts needed to repair the machine. (Southwest Windpower or the Service Center will pay least cost return shipping back to the customer. If express is required, the customer will be required to pay the difference in freight charges.)

7. SPECIFICATIONS

7.1 TECHNICAL SPECIFICATIONS

Rotor Diameter:	46 inches (1.17 meters)
Weight:	13 lb. (6kg)
Start up wind speed:	7 mph (3.0 m/s)
Rated Power:	400 watts at 28 mph (12.5 m/s)
Regulator Set Range:	12v 13.6V – 17.0V preset to 14.1v 24v 27.2V – 34.0V preset to 28.2v
Recommended Fuse Size:	12v - 50 amps slow-blow 24v - 30 amps slow-blow
Yaw Wire Size:	#10 AWG (<i>American Wire Gage</i>) stranded.
Pole Dimensions:	1½ Schedule 40 pipe (<i>outside diameter 1.875 inch, 48mm</i>)

7.2 PERFORMANCE SPECIFICATIONS

The following curve shows the performance you should expect from your **AIR-X** wind turbine. The **AIR-X** is rated with a “band-width” of power for a given wind speed. This is an attempt to cover the variability in turbine output due to different levels of wind turbulence. During smooth, steady wind, you should expect to see outputs along the upper curve. During turbulent wind conditions, the power output could drop towards the lower curve.

To convert between power [watts] and current [amps] use the following formula:

$$\text{POWER} = \text{VOLTAGE} * \text{AMPS}$$

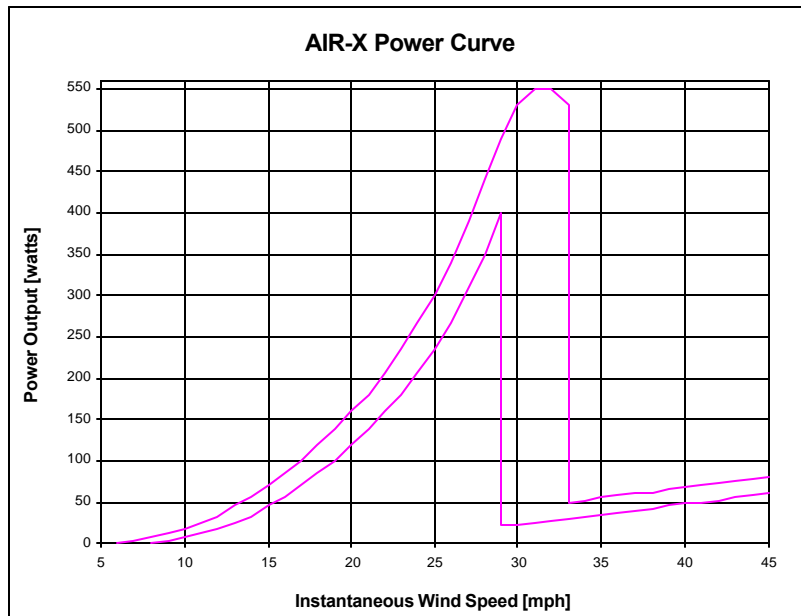

The power curve band-width shown above gives the range of monthly energy production shown below. The energy calculations were done with standard statistical wind speed distributions (Rayleigh distribution, k=2.).

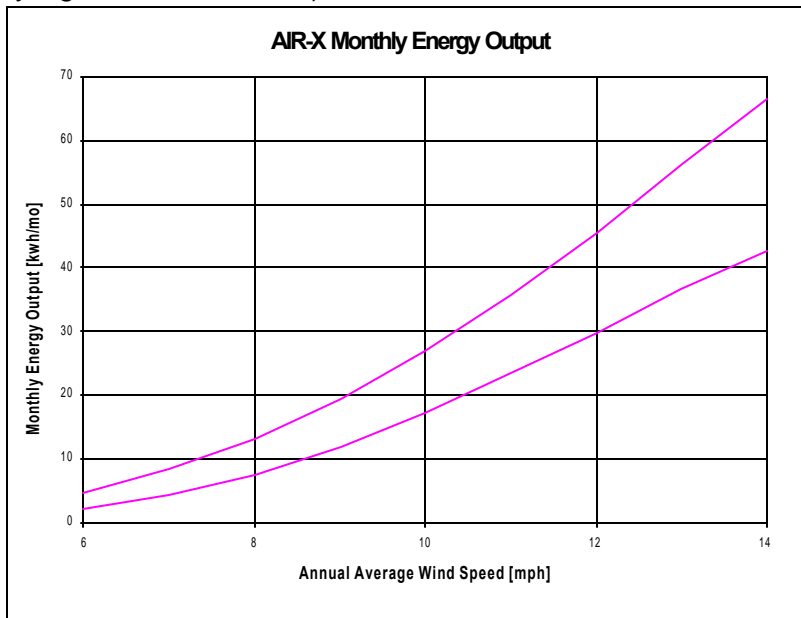

7.3 Sphere of Operation

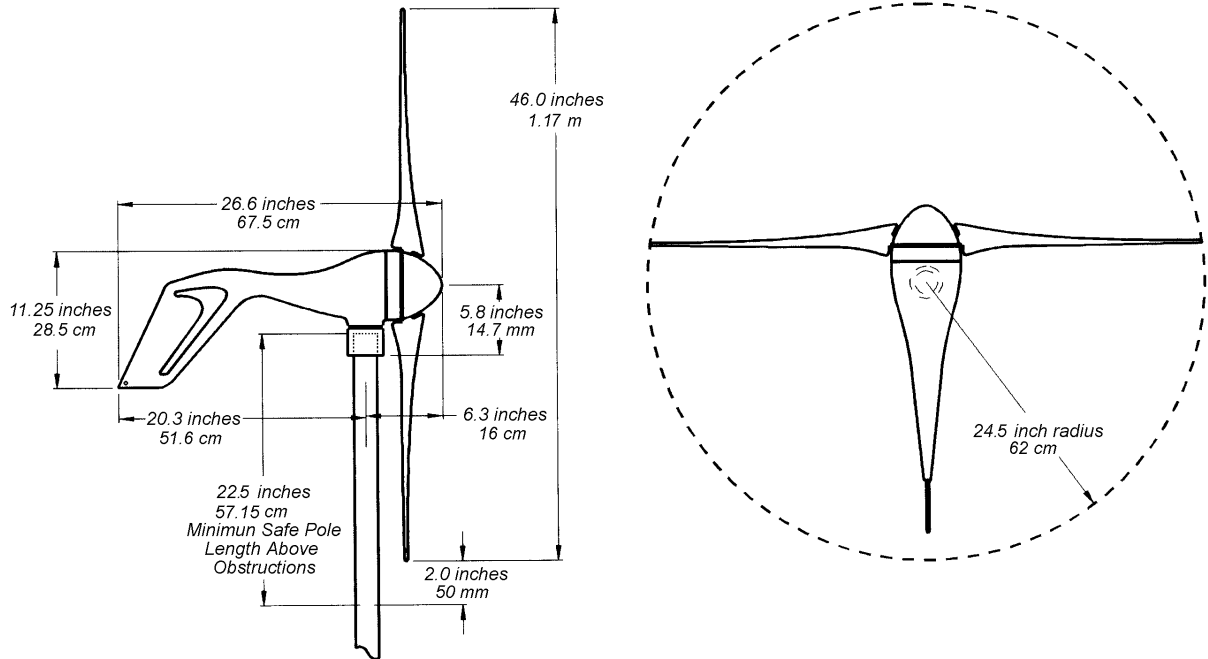

7.4 Exploded View of AIR-X

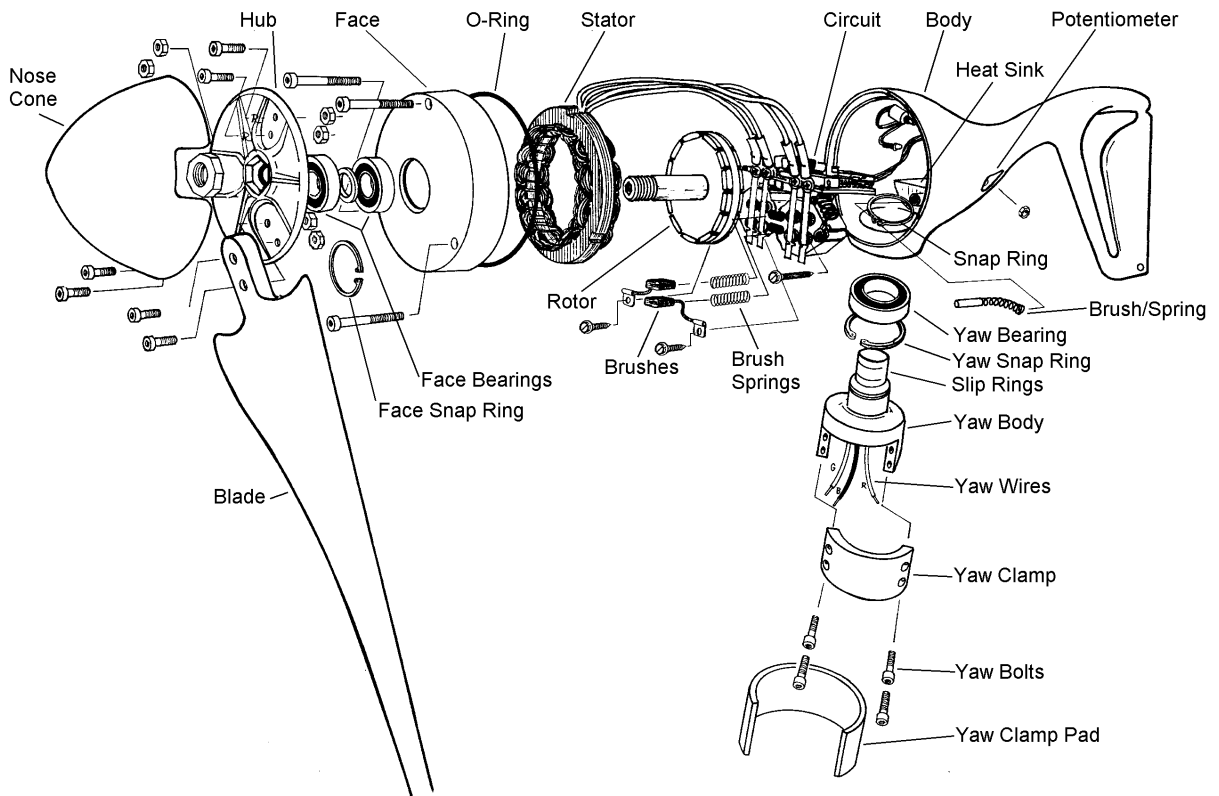

8. MAINTENANCE

Although your **AIR-X** has been designed to run for long periods without requiring any maintenance, reliability and performance will be enhanced if you periodically inspect your system. Before performing any inspection, be sure to shut down the turbine.

CAUTION: NEVER APPROACH THE TURBINE DURING OPERATION.

CAUTION: THE ROTOR BLADES ARE SHARP. PLEASE HANDLE WITH CARE.

The following items should be checked two months after the initial installation and then every six months thereafter:

- Check blades for chips or nicks. Replace blades if damaged. **Do not operate the turbine with chipped or unbalanced blades. This can cause severe wear, damage, and possible failure. Do not install individual blades. The blades are balanced as sets.**
- Check the blade bolts and the hub nut for tightness.
- Make sure the yaw clamp bolts securing your **AIR-X** are tightened to the appropriate torque specification see Section 3.2.1.
- Inspect the tower.
- Dirt or debris build-up on the blades and body may cause a decrease in performance of the turbine and or long-term damage that is not covered by the warranty. Wash off any build-up with clean soap and water.
- Check all electrical connections to make sure they are tight and free from corrosion.
- As with all charging systems, check your battery water levels and add distilled water in accordance with manufacturer's recommendation.
- Check the nose cone.
- Southwest Windpower suggests replacing the blades and bearings every five years for optimal performance.

9. SYSTEM REQUIREMENTS AND CONSIDERATIONS

9.1 Batteries

The following is a brief description of three common batteries. There are many grades, sizes, voltages, and chemistries available. Battery life can vary from less than one year to more than ten years. **It is important to consult your dealer for the most up-to-date information and for help in selecting the appropriate battery.**

NOTE: Never use "automotive batteries" or any non deep-cycle battery.

NOTE: Refer to battery manufacture for specific recommendations regarding installation, maintenance, charging and operation.

Flooded Lead Acid, Wet Lead Acid or flooded lead-acid batteries are the most commonly used batteries to store electrical power. These are available in vented types (most common), where water can be added, and also in sealed types, where water cannot be added.

Absorbed Glass Mat or AGM batteries utilize a fiberglass mat saturated with sulfuric acid. AGM batteries are also sometimes called "starved electrolyte" or "dry", because the fiberglass mat is only 95% saturated with sulfuric acid and there is no excess liquid. An AGM battery is cleaner and can be shipped without any hazardous material requirements. They are far superior for most uses, can take a fair amount of abuse and are non-spilling even when broken. The major disadvantage is a higher cost than a flooded battery, approximately 2 to 3 times. In cases where fumes and leakage are not an issue, the more economical choice is probably a flooded industrial lead-acid

GEL Cell or sealed lead-acid batteries are frequently selected in applications where batteries cannot be vented or cannot be mounted in an upright position. Gel cells are cleaner in the sense that they do not vent gasses like lead acid batteries. However, gel cells are more sensitive to charge voltage (and cannot typically be charged with an automotive type battery charger) since they cannot vent except in emergencies (which may cause irreversible damage). In addition, the gel cells are much more sensitive to higher temperatures and cannot tolerate being discharged for long periods of time relative to a flooded lead acid battery. Therefore, the charge on gel cells must be regulated properly. If using gel cells, follow the manufacturers' recommended regulation set points. Gel cell batteries may require an external battery temperature compensated regulator. Consult your manufacturer for specific recommendations. Specifically, due to the extra cost of gel celled batteries and the temperamental characteristics of these batteries, we do not recommend them.

Nickel Cadmium or Nickel Iron batteries are generally used in extreme conditions. These batteries will perform at temperatures less than -40° C (-40° F). They are capable of delivering higher current and cycle deeper and more often than lead acid AGM and gel batteries. Nickel iron batteries can have a 20+ year life. Nickel iron is one of the most environmentally friendly batteries. However, nickel cadmium batteries contain heavy metals. The disadvantages of this type of battery are its high cost and its low-efficiency charge. Consult your manufacturer for specific recommendations.

The choice of one's battery system is closely connected to where the battery bank is placed and how one chooses to use the battery system. There are several good web sites with information about batteries:

<http://www.batterycouncil.org>

<http://www.buchmann.ca>

http://www.windsun.com/Batteries/Deep_Cycle.htm

If you do not have a battery system already, please consult these resources to make the best choice for your system.

9.2 Regulator Options

The internal electronics protect you and your batteries from excess voltage from the **AIR-X**, they control the turbine rotor RPM, and serve as a sophisticated battery charge regulator. The internal regulator senses the voltage from the battery and determines whether or not to continue charging. Once the battery voltage matches the regulation set point the regulator will “stop” the turbine from charging. (*In high winds there may still be a trickle charge.*)

It is important to keep in mind that battery charge efficiency varies in extreme temperatures. If these conditions exist, an external regulator with a temperature compensation sensor should be used to optimize the charge rate. There are several regulators available that adjust the charge rate based on ambient battery temperature.

There are some conditions in which the **AIR-X's** internal regulator is not appropriate as the primary regulator. These conditions include:

- Systems where battery temperature varies widely
- If batteries are extremely sensitive to charge voltage
- Multiple turbines used with a bus system, where turbine to bus wire lengths or types vary

The **AIR-X** offers you three basic regulation choices:

1. Use the **AIR-X** at its factory settings.

AIR-X Adjustable Voltage Range

12v 13.6v – 17.0v *preset to 14.1v*

24v 27.2v – 34.0v *preset to 28.2v*

2. Adjust the regulator to your systems requirements. The voltage adjustment is external as indicated in Figure 7 on page 17. This allows you to adjust the **AIR-X's** internal regulator to the exact voltage specified by the battery manufacturer. Refer to Section 4.4 on page 22 for regulator adjustment instructions.

NOTE: Refer to the battery manufacturers' specifications for exact regulation set points.

3. Use an external regulator. A standard diversion load regulator like that used with solar panels will work fine. If you choose to use this option you must turn “off” the internal regulator by gently turning the adjustment screw all the way clockwise.

Types Of Regulators

The three types of regulators available are shunt, Pulse Width Modulated (*PWM*) and diversion style regulators. The first two types charge the battery at full turbine output and reduce the output as the battery becomes full. The **AIR-X** is not designed to work with these two types of regulators.

A diversion style regulator charges the battery and as the batteries become charged the excess power is diverted to a resistive load. This allows you to capture full output of the turbine even when the battery is full. The most common use for this excess power is heating water. If you are going to use an external regulator, it is best to use a diversion style regulator.

NOTE: If you elect to use an external regulator, do not use one that will open circuit the turbine as a means of regulation. The **AIR-X** turbine was not meant to operate “open-circuit” for extended periods of time. Most solar controllers will open the solar panel when the

batteries are full and this is perfectly acceptable for solar panels. However, this type of regulation may damage your **AIR-X** by causing it to “freewheel” when the batteries are full. If you choose to use an external regulator, be sure to use a diversion style regulator.

10. SITING

In any location, the closer you get to the surface of the earth, the slower the wind speed. This is a result of the friction of the earth and obstacles on the surface. Turbulence caused by obstacles will reduce the efficiency of any wind turbine. Therefore, locate the turbine in a site that has the “cleanest” free-flowing wind possible.

Power in the wind is the cubic function of the wind speed. This means that small changes in wind speed can have dramatic changes in output. Each time the wind speed doubles, the **AIR-X** is capable of increasing power by eight times! Even slight changes have dramatic effects.

The **AIR-X** should be mounted on a tower a minimum of 25’ (8 meters) above any surrounding objects within a 500’ (150 m) radius. If this is not possible, then place it as high as you can. If this is a roof top installation, it is important there are no objects around the structure that may block the wind.

CAUTION: DO NOT INSTALL THE TURBINE WHERE THE PATH OF THE BLADES CAN BE REACHED.

CAUTION: DO NOT APPROACH THE TURBINE FOR ANY REASON UNLESS ROTOR BLADES ARE STOPPED.

You can get a fairly good estimate of the local average wind speed by looking at the local vegetation. Look at the following drawings for information on estimating your local average wind speed. The first figure shows how tower height can dramatically affect output. This shows how tower height can affect output. *(Figure 8 is only an example of how tower height affects output, not actual outputs of the **AIR-X**).*

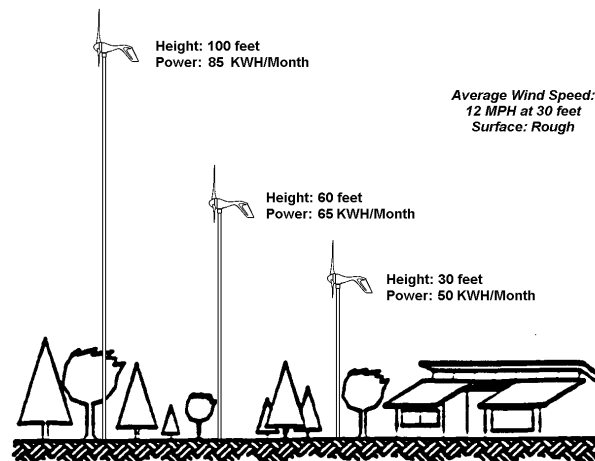
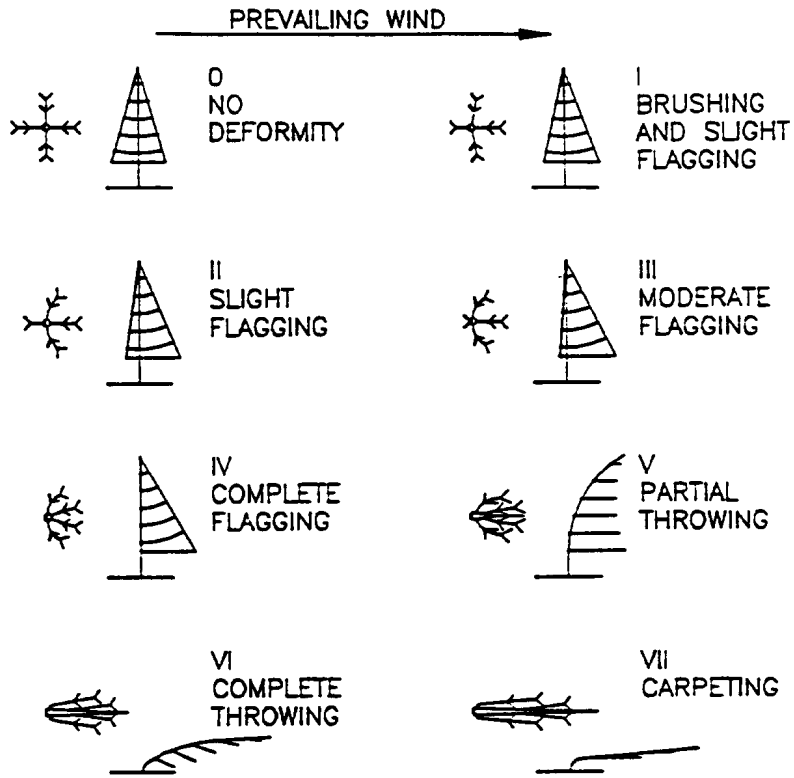

Figure 8



WIND SPEED RATING SCALE BASED ON THE SHAPE OF THE CROWN AND DEGREE TWIGS, BRANCHES AND TRUNK ARE BENT (GRIGGS-PUTNAM INDEX: WADE AND BAKER, 1977)

MEAN ANNUAL WIND SPEED VERSUS THE GRIGGS-PUTNAM INDEX

GRIGGS-PUTNAM INDEX	0	I	II	III	IV	V	VI
PROBABLE MEAN ANNUAL WIND SPEED RANGE (mph)	0-7	7-9	9-11	11-13	13-16	15-18	16-21
WIND SPEED RANGE (m/s)	0-3	3-4	4-5	5-6	6-8	7-9	8-10

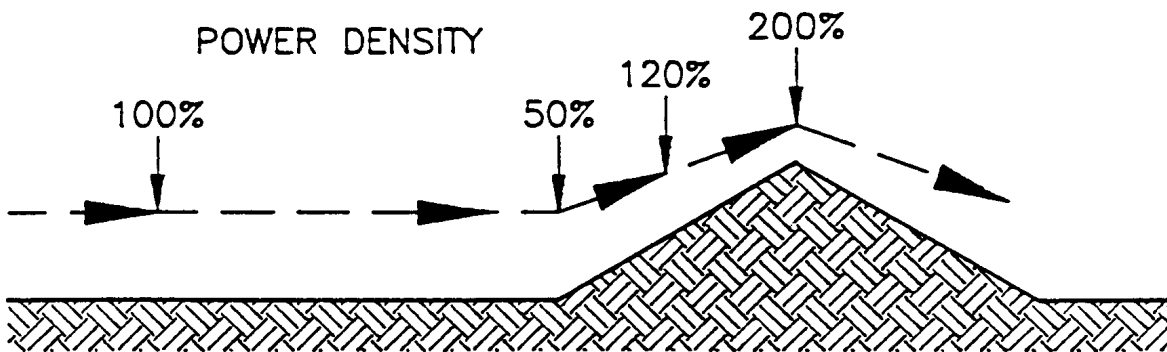

Figure 9

11. TOWERS

There are a few things to consider when choosing the correct tower for your turbine, site and budget. The following is a list of considerations:

- Site: trees, hills, buildings
- Tower budget
- Space for tower; guyed, freestanding, rooftop
- Number of turbines to be installed
- Ease of use

It is important to mount the turbine in the best winds while being balanced by the cost and effort of the installation. As a rule, the higher the tower is erected, the greater the output. However, the taller tower also involves greater tower cost and effort. If purchasing a taller tower will provide significantly more power it might offset the additional cost and effort.

The **AIR-X** is designed to be mounted on tubing or pipe 1.875 inch (48mm) outside diameter. This is equivalent to 1 1/4 inch SCH 40 pipe, which can be used in some tower applications. If larger pipe or tubing is used for part of your tower, make sure that the 1.875 inch pipe that the turbine is mounted to is at least 22.5" long. Larger pipes will reduce the blade tip clearance and may cause damage to the blades. Refer to Section 7.3 on page 31.

CAUTION: PROPER ENGINEERING, SAFETY CONSIDERATIONS AND LOCAL CODES SHOULD BE ADDRESSED BEFORE ATTEMPTING **ANY** INSTALLATION.

NOTE: The yaw wires can support loads up to a total of 150 lbs. (68 kg) in wire weight. For higher wire weights, you must install a strain relief to minimize the stress put on the hanging wires.

NOTE: No more than 8 feet (2.5 m) of pipe should extend from the upper most support.

NOTE: Towers should be capable of withstanding 150 lb. (68 kg) of load in the horizontal direction at the turbine.

11.1 Guyed Towers

Guyed and freestanding towers are the most common way to install a wind generator. These towers are available in all shapes, sizes and costs. As with all towers, you must first evaluate your site to determine the appropriate tower height, available space and reasonable cost. Southwest Windpower offers some very economical tower kits for the AIR series of wind turbines. Please call toll free (866) 806-9463 or visit our website at <http://www.windenergy.com> for more information about Southwest Windpower tower kits.

11.2 Roof Top

One of the revolutionary features of the **AIR-X** is its modular design. This allows for the use of multiple turbines to achieve the desired power production. Roof top mounts offer relatively easy multiple turbine installations if the site allows. Southwest Windpower offers noise isolating roof mounting kits for the AIR series of wind turbines. Again, call or visit our website for more details ((866) 806-9463, <http://www.windenergy.com>).

Basic aerodynamics show that as wind moves over or around objects, the wind compresses and accelerates. It is possible to use a building rooftop to increase the turbine's output using this accelerated wind. The amount of acceleration will vary greatly with house design, wind direction, local obstructions and terrain.

There are considerable differences in acceleration due to the angle and height of a structure and nearby obstructions. However, a location of 5 feet (1.5 m) to 8 feet (2.5 m) above the structure produces substantial acceleration in average situations and is tolerant of different wind directions.

For ideal sites where the prevailing wind is perpendicular to the roof-ridge line, the turbines may be mounted fairly close together 9 feet (2.75 m), center to center. However, if your wind primarily comes from a direction along the roof-ridge line, then the turbines must be spaced to minimize interference 12 to 15 feet (3.6 to 4.5 m) and mounted as high as possible (8 feet (2.5 m) maximum unsupported pipe). Blockage occurs when the wind is parallel to the roofline.

When the prevailing wind is perpendicular to the roof edge, mount your first **AIR-X** in the center of the roof ridge and add modules to either side along the roof ridge. Where the prevailing wind parallels the roof-ridge line, mount your first **AIR-X** on the end of the structure closest to the wind, and about 3 feet (1 meter) from the edge.

Although a rooftop can be used to accelerate the wind flowing past a house, a tower that is much taller will experience higher winds and greater output. The advantages of rooftop mounting are ease of mounting, low tower cost and multiple installations. The disadvantages are lower wind speeds, increased turbulence and potential for noise.

NOTE: Uniform building code requires that a structure must support the wind load it creates by the area presented to the wind. The structural load applied by the wind increases with wind speed. Any additional loads that increase area during serious storms must be compensated for.

NOTE: Any wind generator can create vibration. Always use some type of vibration isolator when attaching the turbine to a structure. The roof mount and house mount tower kits from Southwest Windpower feature vibration isolation mounts and are economical and easy to install. If available it is always better to mount a wind generator on an unoccupied building.

CAUTION: DO NOT INSTALL THE TURBINE WHERE THE PATH OF THE BLADES CAN BE REACHED DURING NORMAL OPERATION.

12. FREQUENTLY ASKED QUESTIONS

These frequently asked questions are subdivided into six categories for ease of reference: General Operation, Installation, Accessories, Wiring, Batteries, and Radio Interference. Please take the time to read through ALL of the questions, and you will have a better understanding of the features and operation of your AIR 403.

General Operation

Why is the AIR so powerful for its size, weight, and cost?

Almost every part of the turbine has been developed from “the ground up” using 3-D computer models to help analyze every element of the design. As a result, this state-of-the-art turbine features the following:

- **The AIR-X is the only small battery charging wind turbine that uses a microprocessor to track the cubic power of the wind and adjust and stall the permanent magnet (PM) alternator accordingly. Other PM alternators are linear in their output and either stall or unload the rotor blades making them very inefficient.**
- **The AIR uses 12 Neodymium Iron Boron magnets, which are the strongest magnets available in the world.**
- **This is the first wind turbine to use blades with advanced airfoils made of injection-molded carbon-composite materials that meet the strength-to-weight ratio requirements of this computer assisted design.**
- **The microprocessor controlled circuit and alternator allows the turbine to self-regulate in high winds and to automatically stop when the batteries are charged.**

Most important, is the conviction and passion of our team. While overcoming seemingly insurmountable obstacles, together we have maintained our desire to help change the world by providing quality renewable energy innovations.

#1 How does the AIR regulate my batteries?

The internal circuitry monitors the voltage at the output of the turbine. When the maximum charging voltage is reached (adjustable by the potentiometer on the side of the turbine) the Autobrake is engaged. This cuts off the turbine output, and the blades are braked to a slow rotation. The Autobrake remains on until the voltage drops to a level slightly below that of a fully charged battery (12.6V for 12V, 25.2V for 24V) At this point the Autobrake releases and the turbine resumes charging.

#2 Can the output of my AIR be changed by the potentiometer?

The **AIR-X** produces 100% of the power of which it is capable according to the wind speed. The potentiometer only changes the voltage setting at which the Autobrake engages. Changing this setting will not increase the ampere output of the machine but may overcharge your batteries.

#3 How do I adjust the regulator to stop charging at a specific battery voltage?

Refer to Section 4.4 on page 22.

#4 How does the AIR-X control power and RPM in high winds?

The microprocessor in the **AIR-X** constantly monitors turbine RPM, and is programmed to stall the blades in high winds. The blades are put into a low efficient region which drops the turbine to roughly $\frac{1}{4}$ of its peak RPM. This allows the turbine to survive high wind events with low mechanical stresses. Also, since the blades are running inefficiently in stall mode, they are not delivering substantial power to the electronics, and the alternator and the power electronics remain cool in stall mode. When the microprocessor senses that the wind speed has dropped, it will release the **AIR-X** from stall mode, and normal charging will resume.

#5 What is the maximum wind speed the AIR-X will survive, and do I need to take it down in a storm?

NEVER approach the **AIR-X** or any turbine in strong wind conditions. The **AIR-X** is designed to run without attention in storm conditions; however, if you wish to shut down the turbine you can do that remotely as described in Section 3.1.5 on page 12. The **AIR-X** is rated to 110 mph. If you expect higher winds, shut down the turbine and either lash down the blades or remove the hub and blade set.

#6 How long will the bearings or other wearing parts last?

According to engineering calculations, the bearings should have a 10-year life in 12-mph (6 m/s) average wind speed sites. Bearing life will vary from one application to another; however, you should expect at least a five-year performance in adverse conditions and 10 years in normal conditions.

The copper brushes should last a lifetime. The yaw shaft has been tested to over 100,000 revolutions with no visible wear on the brushes or slip rings.

#7 Why is there a cut-out in the tail?

The cutout helps to balance the AIR on its turning axis to better track the wind and to give it stability in rough seas. This balance keeps the turbine pointed into the wind even when the boat is heeled over. Since the turbine is properly balanced, more power can be extracted from the wind no matter how slight or directionally unstable.

Installation**#8 Can the AIR be connected in reverse-polarity to the battery without causing any damage?**

NO! If you connect the turbine in reverse-polarity to the battery you will damage the turbine and void your warranty. Make sure to connect the positive (red) wire to the positive post on the battery, and connect the negative (black) wire to the negative battery post.

#9 Will it hurt my AIR to short-circuit the output?

No, the **AIR-X** is designed to be short-circuited as a normal shutdown procedure. The function of the stop switch is to both disconnect the turbine from the batteries as well as short-circuit the output of the turbine. **BE SURE NOT TO SHORT YOUR BATTERIES!**

#10 Will it not short my batteries when I use a stop switch?

When a single pole, double throw switch that is rated for proper current and voltage is connected as shown in the manual, the turbine positive is disconnected from the batteries BEFORE being connected to negative. It is important that your stop switch be of the type that opens the circuit between positions. This is commonly referred to as a "break-before-make" switch. Be sure to install a fuse in any case.

#11 How do I know the AIR is charging?

For a precise indication of charge current you will need to install an amp meter in your system. The meter or meter shunt should be installed in-line on the positive wire. The meter should be located on the wiring between the stop-switch (if used) and fuse or breaker. Southwest Windpower carries a 0-30A, analog (needle-reading) meter that may be purchased directly if one is difficult to find in your area.

#12 I can measure a small amount of current back-feeding to my AIR. Is this normal?

The **AIR-X** internal circuitry consumes a maximum of about 20 mA when it is not charging. This is about the same current draw as a small clock. If you are concerned about this small amount, you can install a stop switch and switch to "OFF" to disconnect the turbine.

#13 The open-circuit voltage of my AIR is far above my batteries. Is this normal?

When connected to batteries, the AIR spins freely until it reaches the battery voltage. When the voltage of the turbine rises above battery voltage, current (amps) begins to flow, as current is a function of a difference in voltage. The greater the difference in voltage, the greater the current is.

If no battery is connected, then the turbine will continue to increase in voltage (provided there is sufficient wind) until almost double the rated voltage is reached. At this point the Autobrake is engaged and the turbine slows down. For a 12V turbine this happens at about 20V, and for a 24V turbine this happens at about 40V.

It should be noted that, when the turbine is open circuit (not connected to batteries), the Autobrake will slow the blades, and the voltage from the turbine will drop. The Autobrake will release until the blades spin up again, and then re-engage. This leads to an oscillation that is more strenuous on the turbine than normal operation. For this reason you must short the positive turbine output wire to the turbine negative wire whenever it is not connected to a load to achieve the maximum life from your turbine.

If you observe your turbine oscillating in the manner described above, check the fuse or breaker for the turbine as it may be expired.

#14 I'm not ready to attach my wires to the batteries. Can I simply leave the AIR wires unattached?

Always short the **AIR-X** negative to positive when it is disconnected from your system, and the blades are installed. **BE SURE NOT TO SHORT YOUR BATTERIES!** The turbine will prevent itself from over-speeding and over voltage, but as explained above, this is a high-wear condition for the turbine and should not be left that way for any substantial amount of time.

#15 I have multiple turbines installed on my system, and they seem to function erratically. Why is this?

Check your wire sizes to be sure they are at least as big as those specified in your **AIR-X** manual (bigger is always better, but more expensive.) Be sure all of your wire connections are very solid, have no gaps, have no corrosion, and no crimp terminals are used. If your turbines are at various distances from the batteries, make sure turbines with longer wire runs have bigger wires.

There will be some variation at what voltage turbines will enter into regulation based on the relative wind to which each turbine is exposed. Small differences in line loss can be significant in strong winds.

Accessories

#16 Where can I locate a stop switch?

If you want to install a stop switch it must be a 50-amp or greater DC Single-Pole Double-Throw toggle switch (see Section 3.1.5 on page 12). This can be purchased from some automotive electrical repair shops, your dealer, or from Southwest Windpower directly.

#17 Can I use household AC fuses or breakers to fuse my AIR?

You should only use DC rated devices with your **AIR-X**, as AC components are typically sized differently. Because DC breakers and fuses in the required sizes may be hard to find in your area, Southwest Windpower carries a 30A and 50A breaker. You may purchase these from some local dealers and distributors or from Southwest Windpower direct.

#18 Can I use an external charge controller to regulate my AIR?

We recommend using only diversion load type charge regulators with the **AIR-X**. These regulators divert excess power to a heating element or power resistor when the batteries are full. This excess power can be used to assist in hot water or room heating. PV type regulators should never be used. Series type regulators that disconnect the power source when batteries are full will often give undesirable results such as causing the Autobrake to fluctuate on and off when the batteries become full.

#19 I just installed my AIR with an automotive style amp meter, but I don't see any current. How can this be?

Given that all wiring has been done correctly, and other precautions have been heeded, chances are that the amp meter is wired backwards and the needle is attempting to move in the negative direction. If "zero" is on the left-hand side of the meter, then the needle cannot move and looks as if the unit is not producing. Simply reverse the leads on the meter and see if current will register.

#20 Where can I locate tubing to make a tower?

The AIR-X uses 1 1/2" schedule 40 steel pipe. (Actual outside diameter (O.D.) of the pipe is 1.875 inches, 48 mm) Steel pipe is available at any hardware or plumbing store. Fencing supply stores can also be an excellent source for steel tubing.

Wiring

#21 The recommended wire sizes on your chart seem small for 400 Watts output. Why is that?

Because the output of the AIR follows the cubic power in the wind, the output increases rapidly with increasing wind speed until over-speed stall occurs and the output power drops off to about 75 watts. The wiring could be sized for the maximum current output of the turbine, but this output is seen primarily in gusty conditions.

We have recommended wire sizes that are intentionally small to save the customer from spending a lot of money on wiring, while still experiencing no more than a 5% annual energy loss due to resistive line losses. In most cases this will be acceptable for local electric codes – please contact your installer or local electrician to be certain of your area's specific requirement.

#22 What is the difference between copper and aluminum wire?

Aluminum wire is less conductive; so generally it must be bigger for the same amp load and resistive losses as copper. The **AIR-X** uses copper or tinned copper for the yaw wires.

#23 What is the difference between welding cable and standard stranded cable?

Welding cable is typically very finely stranded to be very flexible, where as standard cable will typically hold its shape. Always be sure that the environmental rating of the insulation of your power cable matches the application.

#24 Why does my AIR regulate before my batteries are fully charged?

This can happen if the AIR is connected in parallel with another charging source, and there is some distance between this connection and the batteries. The other charging source can create a voltage drop because of its own current output, which will raise the voltage that the turbine "sees".

Be sure to check ALL of your wire connections. All connections should be soldered, split bolted, or secured in a terminal block. CRIMP-ON TYPE CONNECTORS MUST NEVER BE USED! These are poor connectors for high currents and will almost always have some resistance at the male/female connection that will increase your voltage drop and line loss.

#25 How does wire sizing or voltage drop affect the regulation of my AIR?

Due to the smart controller of the **AIR-X**, wire size should not have a large effect on the regulation. The **AIR-X** uses the power lines to sense battery voltage, but before measuring the battery voltage, the AIR-X will momentarily stop charging. This allows the turbine to make a voltage measurement with no line loss in the system. This is an improvement over the AIR 403 which can only measure the battery voltage plus line loss in the system. The voltage measurement routine takes place periodically as the batteries approach the regulation set point. Output is cut for a fraction of a second, and the whole process will not be apparent from the outside. It will not affect the net energy generation of the turbine.

At a minimum, Southwest Windpower still recommends using the wire size listed for your system in section 3.1.2 to avoid power transmission losses.

Batteries

#26 What kind of batteries should I use with my AIR?

Only batteries intended for power system applications should be used. This means “deep cycle” type batteries, and not the Marine deep cycle type as these are not intended for the same application. Typically “true” deep-cycle batteries will be rated in amp-hours and have some indication of the number of charge-discharge cycles that are available. Beware of the dubious claims of “deep-cycle” claimed by the manufacturers of inexpensive batteries.

#27 Why shouldn't I use automotive batteries in my DC system?

Automotive batteries are meant to discharge a large amount of current in a very brief time. The lead plates are thinner and often porous to allow rapid discharge. They will also wear faster and are not intended to be discharged far below their normal voltage. True deep cycle batteries are intended for more moderate loading and deeper discharge, and are made with thicker, longer lasting plates. The casing and construction of batteries intended for renewable energy systems is typically much tougher and of higher quality than automotive batteries.

#28 Is lightning protection necessary?

Lightning protection is ALWAYS a good idea when erecting a metal tower. The Delta Lightning Arrestor (model LA 301-DC) is widely used in outdoor power and antenna applications. While this is still no guarantee that Mother Nature won't find a way, these arrestors are not very expensive and may save some very expensive equipment.

Radio Interference**#29 What effect does radio interference have on my AIR-X?**

The internal circuitry of the *AIR-X* is shielded and filtered to prevent radio interference, and has been tested to insure electro-magnetic compatibility.

#30 What effect does my AIR have on radio transmissions?

The *AIR-X* normally does not affect radio transmitters. Care should be taken, however, to route power lines from the *AIR-X* away from the power and antenna lines of a radio transmitter. An old ham radio operator's trick is to twist positive and negative wires together to provide an even distribution of EMF noise across both wires, which serves to cancel out the electrical noise created. This technique can be used on the *AIR-X* power lines, on the radio's power lines, and on transmission wires. Transmission lines should always be kept as far from power lines as is practically possible. Proper grounding of the *AIR-X* and other system components must also be observed.

#31 Will it affect the regulation of my AIR-X to install an RF (radio frequency) filter?

An RF filter should not affect the regulation of the *AIR-X*, but any electronic devices placed in line with the turbine must be rated for the proper current and voltage. It is best to place any line filters on the power lines for the load device (transmitter) that requires it, and as close to the device as possible.

13. ACCESSORIES

Southwest Windpower offers a line of accessories for your turbine. Some of these accessories are difficult to find due to the high DC outputs. We offer them as a convenience to you. They may be available at an automotive parts store. Otherwise you can purchase them from your dealer/distributor or directly from Southwest Windpower.

Stop Switch

The 50-amp DC Stop Switch can be used to “stop” the turbine for service or any other reason. Refer to the Stop Switch wiring diagram in Section 3.1.5 on page 12. A stop switch is not necessary, but most customers find it very useful.

Amp Meter

The Amp Meter allows you to monitor the output of your turbine. Place it in between your turbine and the battery on the positive lead. It will give you instantaneous readings of output in amps.

Circuit Breaker

A Circuit Breaker is required with any electrical installation. In the event of a system or turbine failure the circuit breaker disconnects the battery and prevents the possibility of further damage. Make sure to purchase the proper size DC breaker.

12 volt = 50 amp

24 volt = 30 amp

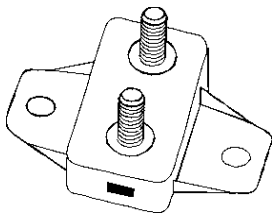

Circuit Breaker
30A: PN XXA05
50A: PN XXA06

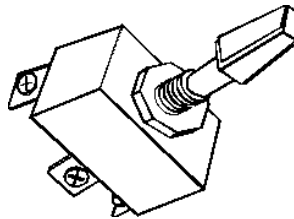

Stop Switch
PN XXA03

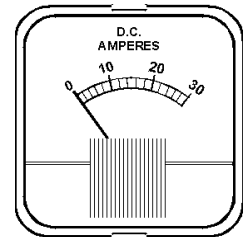

Amp Meter
PN XXA04

Guyed tower Kits

We offer 27' (8.2 m) and 45' (13.7 m) guyed towers. These towers are relatively low cost and easy to install. Contact your dealer or Southwest Windpower for pricing and product information. You can call Southwest Windpower toll free at (866) 805-9463 or visit our website at <http://www.windenergy.com>.

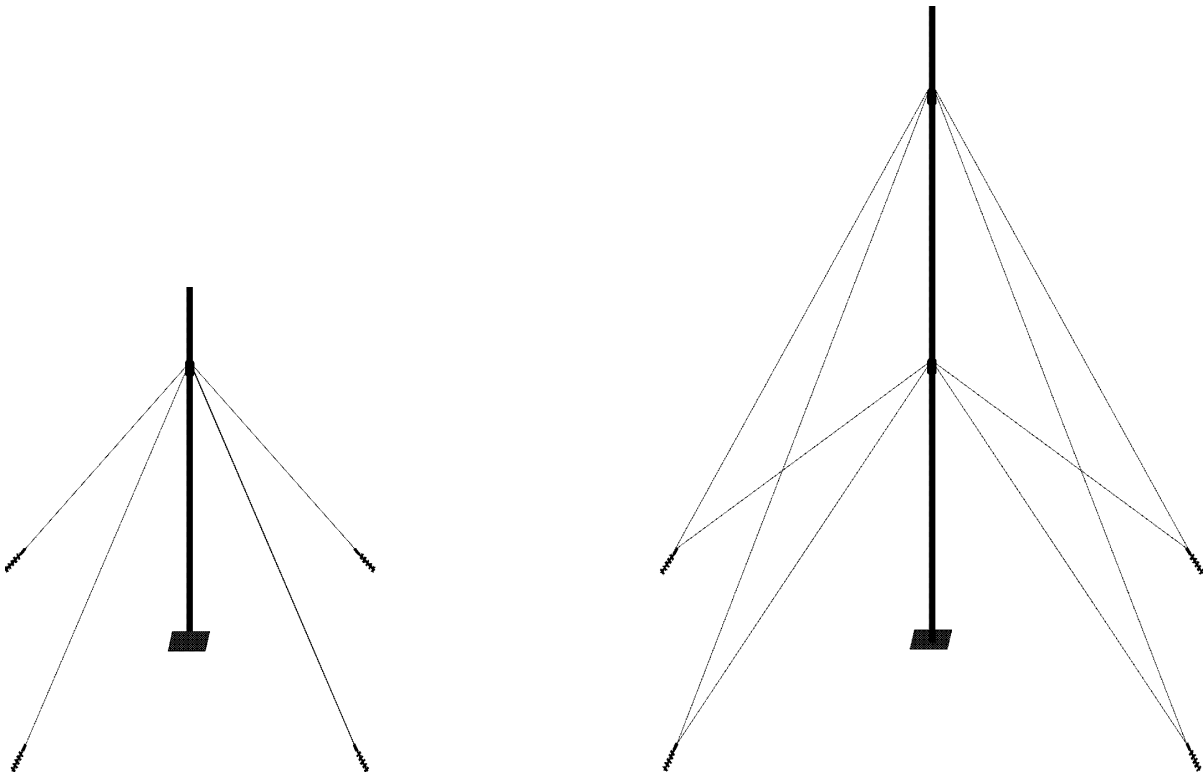

14. REFERENCES

Wind Energy

The Wind Power Book

J. Park Hackleman
Cheshire Books, 1981
Palo Alto, CA

The Home Built, Wind Generated Electricity Handbook

M. Hackleman
Peace Press, 1975
Culver, CA

Wind Energy, How To Use It

P. Gipe
Stackpole Books, 1983

Wind Power For The Home Owner

D. Marier
Rodale Press
Emmaus, PA

Batteries

The Battery Book

R. Perez
Home Power Magazine
P.O. Box 520
Ashland, OR 97520
(970) 475-0830

Websites

<http://www.batterycouncil.org>

<http://www.buchmann.ca>

http://www.windsun.com/Batteries/Deep_Cycle.htm

Siting

A Siting Handbook for Small Wind Energy Conversion Systems

H.L. Wegley, J.V. Ramsdell, NM Orgill, and R.L. Drake
National Technical Information Service, 1980
(703) 487-4600

Tower Construction

Uniform Building Code - Section 2311 - Wind Design

UBC International Conference of Building Officials, May 1985

Lightning Protection

Lightning Protection

R.H. Golde
Chemical Publishing Co., Inc., 1975
New York

Lightning Code Section 78

National Fire Codes, Volume 7, 1978
National Fire Protection Association
(Available at your Library)

Resources

National Renewable Energy Lab (NREL)
1617 Cole Blvd
Golden, CO
80401-3393
(303) 275-3000
<http://www.nrel.gov>

National Technical Information Service
United States Department of Commerce
5285 Port Royal Rd.
Springfield, VA 22161
(703) 487-4600

The American Wind Energy Association (AWEA)
122 C Street NW, Fourth Floor
Washington, D.C. 20001
(202) 408-8988
<http://www.awea.org>

NRG Systems (Monitoring Equipment Manufacturer)
110 Commerce Street
Hinesburg, VT 05461
(802) 482-2255

National Electrical Codes

National Electrical Code (NEC)
National Fire Protection Association